



DSM/DWR Models

Dual Output, 3.3V and 5V, 15Watt DC/DC Converters

FEATURES

- Regulated 5V and 3.3V outputs
- 5V @ 2.5mA / 3.3V @ 400mA (Capacitor)
- 5 Watts total output power
- 1" x 2" Surface Mount Through-Hole Packaging
- Available input voltage ranges: 10-18V, 18-36V or 36-75V

NOT RECOMMENDED FOR NEW DESIGNS

- No-load stable operation
- UL/EN60950-1 safety approvals
- CE mark available (75V-input models)
- Continuous short-circuit protection
- Fully isolated, 1500Vdc guaranteed
- -40 to +100°C operating temperature
- Input under and overvoltage shutdown
- Output OVP, thermal shutdown

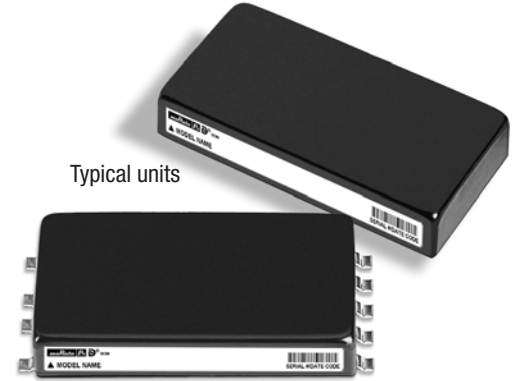

PRODUCT OVERVIEW

For surface mount or through-hole applications requiring 15 Watts of power from 5V and 3.3V, DATEL offers a new power sharing DC/DC converter capable of meeting your output current requirements. The DSM/DWR series is available with three different input voltage ranges: 36-75V input (D48), 18-36V input (D24) or 10-18V input (D12). These converters are fully isolated and capable of delivering any combination of 5V and 3.3V output current up to a combined total of 15 Watts of output power.

Housed in 1" x 2" metal packages coated with electrically non-conductive finish, DSM/DWR converters are regulated by a 3.3V control loop that provides load regulation of $\pm 0.5\%$ for 3.3V output and $\pm 1.5\%$ for 5V output.

All models include input filtering, input overvoltage and undervoltage shutdown circuitry, output short-circuit and current-limiting protection, and thermal shutdown. All models provide trim capability and an on/off control function. Fully synchronous output rectification provides high efficiency (86%) and a stable output under no-load conditions.

DSM/DWR power sharing modules offer low output ripple and noise performance, 1500 Vdc isolation voltage, and are fully specified for -40 to +100°C operation. These devices meet IEC950, UL1950 and EN60950-1 safety standards. "D48" models are CE marked (meets LVD requirements).

SIMPLIFIED SCHEMATIC

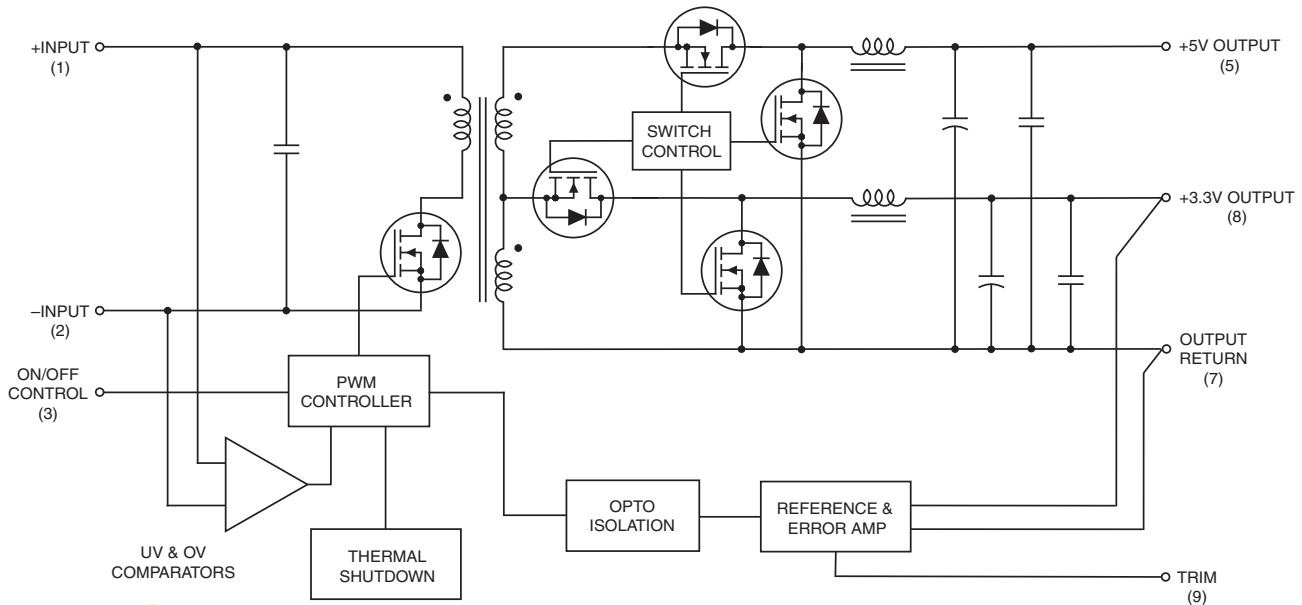

Figure 1. Simplified Schematic

Typical topology is shown.



For full details go to www.murata-ps.com/rohs

Performance Specifications and Ordering Guide^①

Model	V _{OUT} (Volts)	I _{OUT} (Amps)	Output		Regulation (Max.)		V _{IN} Nom. (Volts)	Input Range (Volts)	I _{IN} (mA)	Efficiency		Package (Case, Pinout)
			R/N (mVp-p) ^③	Typ.	Max.	Line				Load ^④	Min.	
OBSOLETE *DSM-5/2.65-3.3/3-D12-C	5	2.65	40	75	±1%	±1.5%	12	10-18	60/1450	83%	86%	C18A, P36 C34, P36
OBSOLETE *DWR-5/2.65-3.3/3-D12-C	3.3	3	60	100	±0.5%	±0.5%						
DSM-5/2.65-3.3/3-D24-C	5	2.65	40	75	±1%	±1.5%	24	18-36	35/730	83%	85%	C18A, P36 C34, P36
DWR-5/2.65-3.3/3-D24-C	3.3	3	60	100	±0.5%	±0.5%						
OBSOLETE *DSM-5/2.65-3.3/3-D48-C	5	2.65	40	75	±1%	±1.5%	48	36-75	20/370	83%	85%	C18A, P36 C34, P36
OBSOLETE *DWR-5/2.65-3.3/3-D48-C	3.3	3	60	100	±0.5%	±0.5%						

- ① Typical at T_A = +25°C under nominal line voltage and balanced "full-load" conditions (5V @ 1.5A/3.3V @ 2.25A).
- ② Any combination of 5V/3.3V rated I_{OUT} current, not to exceed 15 Watts of output power. (See derating graphs.)
- ③ Ripple/Noise (R/N) measured over a 20MHz bandwidth. All models are specified with 0.47µF ceramic in parallel with 100µF tantalum output capacitors.
- ④ Tested from 250mA to 100% full load (other output at 250mA load).
- ⑤ Nominal line voltage, no load/balanced full-power condition.

*** LAST TIME BUY: AUGUST 31, 2014. CLICK HERE FOR OBSOLESCENCE NOTICE OF FEBRUARY 2014.**

As of September 2014, ONLY the following part numbers will be available: DSM-5/2.65-3.3/3-D24-C; DSM-5/2.65-3.3/3-D24L1-C; DWR-5/2.65-3.3/3-D24-C.

PART NUMBER STRUCTURE

DSM - 5 / 2.65 - 3.3 / 3 - D48 LX - C

Dual Output:
DSM: Surface-Mount Series^②
 (Selective soldering only)
DWR: Through-Hole Series

V₁ Nominal Output Voltage:
 5 Volts

I₁ Maximum Output Current:
 2.65 Amps

V₂ Nominal Output Voltage:
 3.3 Volts

I₂ Maximum Output Current:
 3 Amps

Input Voltage Range:
D12 = 10-18 Volts (12V nominal)
D24 = 18-36 Volts (24V nominal)
D48 = 36-75 Volts (48V nominal)

RoHS-6 compliant

See Optional Functions

Optional Functions

DSM/DWR 15 Watt DC/DC's are designed with an On/Off Control function, with positive polarity in the pin 3 position.

Blank = On/Off Control function (positive polarity) on pin 3 only

L1 = Pin length: 0.110 inches (2.79mm) ±0.010
L2 = Pin length: 0.145 inches (3.68mm) ±0.010

- ① **Special quantity order is required; samples available with standard pin length only.**
- ② **SMT (M) versions not available in sample quantities.**
- ③ **Some model number combinations may not be available. See website or contact your local Murata sales representative.**

MECHANICAL SPECIFICATIONS

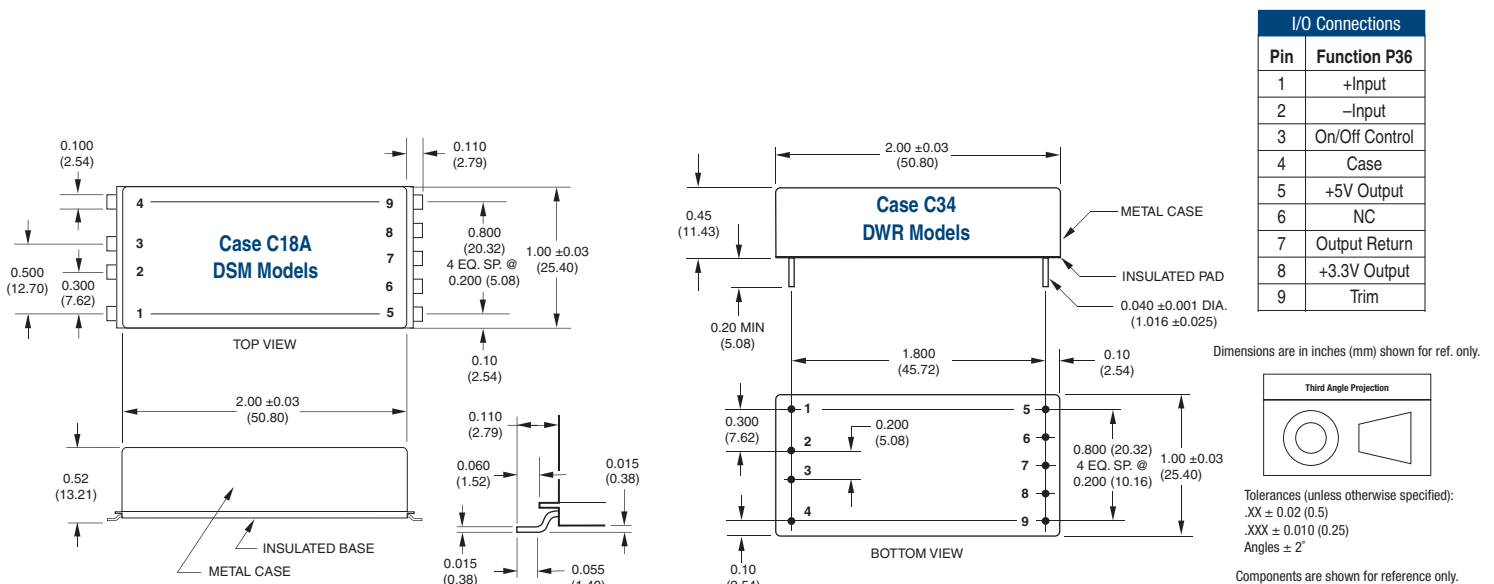

Performance/Functional Specifications

Typical @ T_A = +25°C under nominal line voltage, balanced "full-load" conditions, unless noted. ①

Input	
Input Voltage Range:	
D12 Models	10-18 Volts (12V nominal)
D24 Models	18-36 Volts (24V nominal)
D48 Models	36-75 Volts (48V nominal)
Overvoltage Shutdown:	
D12 Models	18.5-21 Volts (19V typical)
D24 Models	37-40 Volts (38.5V typical)
D48 Models	77-81 Volts (79.5V typical)
Start-Up Threshold:	
D12 Models	9.4-10 Volts (9.6V typical)
D24 Models	16.5-18 Volts (17V typical)
D48 Models	34-36 Volts (35V typical)
Undervoltage Shutdown:	
D12 Models	7.0-8.5 Volts (8V typical)
D24 Models	15.5-17.5 Volts (16.5V typical)
D48 Models	32.5-35.5 Volts (33.5V typical)
Input Current:	
Normal Operating Conditions	See Ordering Guide
Standby Mode:	
Off, OV, UV, Thermal Shutdown	10mA
Input Reflected Ripple Current ⑧	10mA _{p-p}
Internal Input Filter: Capacitive	
D12 Models	10µF
D24 Models	3.3µF
D48 Models	1.5µF
Reverse-Polarity Protection:	
D12 Models	1 minute duration, 3A maximum
D24 Models	1 minute duration, 2A maximum
D48 Models	1 minute duration, 1A maximum
On/Off Control: (Pin 3): ③ ⑤	On = open or to +15V, I _{IN} @ 13V = 800µA Off = 0 to 0.8V, I _{IN} @ 0V = 2mA
Output	
V_{OUT} Accuracy:	
5V Output	±2.5% maximum
3.3V Output	±1.5% maximum
Minimum Loading Per Specification ⑦	250mA
Minimum Load For Stability	No load
Ripple/Noise (20MHz BW) ④	See Ordering Guide
Line/Load Regulation	See Ordering Guide
Efficiency	See Ordering Guide / Efficiency Curves
Cross Regulation:	
5V Output	
(5V @ 1.5A, 3.3V @ 0.25-2.25A)	±2%
3.3V Output	
(3.3V @ 2.25A, 5V @ 0.25-1.5A)	±0.5%
Trim Range ②	±5%
Isolation Voltage:	
Input-to-Output	1500Vdc minimum
Input-to-Case	1000Vdc minimum
Output-to-Case	1000Vdc minimum
Isolation Capacitance	560pF
Isolation Resistance	100MΩ
Current Limit Inception:	
5V @ 95% V _{OUT} (3.3V @ 0.25A)	3.3-4 Amps
3.3V @ 97% V _{OUT} (5V @ 0.25A)	4.7-5.7 Amps

Output (continued)	
Short Circuit Current:	
5V Output	5.5 Amps average, continuous current
3.3V Output	3 Amps average, continuous current
Maximum Capacitive Loading	330µF per output
Temperature Coefficient	±0.02% per °C
Dynamic Characteristics	
Dynamic Load Response: ②	
5V (50-100% step to 98% V _{OUT})	200µsec maximum (3.3V @ 0.25A)
3.3V (50-100% step to 98.5% V _{OUT})	200µsec maximum (5V @ 0.25A)
Start-Up Time:	
V _{IN} to V _{OUT}	10msec
On/Off to V _{OUT}	10msec
Switching Frequency	260kHz (±25kHz)
Environmental	
MTBF: ⑥	
D12 Models	TBD hours
D24 Models	2.1 million hours
D48 Models	2.4 million hours
Operating Temperature: (Ambient): ②	
Without Derating:	-40 to +60°C
With Derating	To +100°C (See Derating Curves)
Case Temperature:	
Maximum Operational	+100°C
For Thermal Shutdown	101°C minimum, 115°C maximum
Storage Temperature	-40 to +120°C
Physical	
Dimensions	See Mechanical Specifications
Internal Case Connection	Case connection via pin 4
Case Material	Corrosion resistant steel with non-conductive, epoxy-based, black enamel finish and plastic baseplate
Pin Material	Gold-plate copper alloy pins or tin-plate copper alloy SMT contacts
Weight	1.6 ounces (46 grams)
Primary to Secondary Insulation Level	Operational

① Balanced "full-load" is 5V @ 1.5A/3.3V @ 2.25A. All models are specified with external 0.47µF ceramic and 100µF tantalum output capacitors.

② See Technical Notes/Graphs for details.

③ Applying a voltage to On/Off Control (pin 3) when no input power is applied to the converter can cause permanent damage.

④ Output noise may be further reduced with the installation of additional external output capacitors. See Technical Notes.

⑤ On/Off control is designed to be driven with open collector or by appropriate voltage levels. Voltages must be referenced to the -Input (Pin 2).

⑥ Demonstrated MTBF available on request.

⑦ For conditions with less than minimum loading, outputs remain stable. However, regulation performance will degrade.

⑧ Input Ripple Current is tested/specified over a 5-20MHz bandwidth with an external 22µF input capacitor and a simulated source impedance of 220µF and 12µH. See I/O Filtering, Input Ripple Current and Output Noise for details.

Absolute Maximum Ratings		
Input Voltage:		
Continuous:	D12 Models	21 Volts
	D24 Models	40 Volts
	D48 Models	81 Volts
Transient (100msec):	D12 Models	25 Volts
	D24 Models	50 Volts
	D48 Models	100 Volts
Input Reverse-Polarity Protection: ②		
	Input Current must be limited. 1 minute duration. Fusing recommended.	
D12 Models	3 Amps	
D24 Models	2 Amps	
D48 Models	1 Amps	
Output Current ②		
Current limited. Devices can withstand an indefinite output short circuit.		
On/Off Control (Pin 3) Max. Voltages:		
Referenced to -Input (pin 2)	+15V	
Storage Temperature		
-40 to +120°C		
Lead Temperature (Soldering, 10 sec.)		
+300°C		
<small>These are stress ratings. Exposure of devices to greater than any of these conditions may adversely affect long-term reliability. Proper operation under conditions other than those listed in the Performance/Functional Specifications Table is not implied, nor recommended.</small>		

TECHNICAL NOTES

Isolation / Case Connection

The XWR Series' 5V and 3.3V outputs (pins 5 & 8) with its common return (pin 7) are isolated from the +VIN and -VIN inputs (pins 1 & 2) via a transformer and an opto-coupled transistor.

The DC/DC converter's case is internally connected to pin 4. This allows circuit specific grounding of the case on either the input or the output side, or leaving the case disconnected, i.e. "floating."

Input Fusing

Certain applications and/or safety agencies may require the installation of fuses at the inputs of power conversion components. Fuses should also be used if the possibility of a sustained, non-current-limited, input-voltage polarity reversal exists. For XWR 15 Watt Series Converters, it is recommended to install slow blow fuses with values no greater than the following, in the +Input line.

V _{IN} Range	Fuse Value
D12 Models	3 Amps
D24 Models	2 Amps
D48 Models	1 Amps

Input Reverse-Polarity Protection

Upon applying a reverse-polarity voltage to the DC/DC converter, an internal diode will be forward biased, drawing excessive current from the power source. Therefore, it is required that the input current be limited by either an appropriately rated input fuse or a current limited power source.

Input Overvoltage/Undervoltage Shutdown and Start-Up Threshold

Under normal start-up conditions, devices will not begin to regulate until the ramping-up input voltage exceeds the Start-Up Threshold Voltage (35V for

D48 models). Once operating, devices will not turn off until the input voltage drops below the Undervoltage Shutdown limit (34V for D48 models). Subsequent re-start will not occur until the input is brought back up to the Start-Up Threshold. This built in hysteresis prevents any unstable on/off situations from occurring at a single input voltage.

Input voltages exceeding the input overvoltage shutdown specification listed in the Performance/Functional Specifications will cause the device to shut-down. A built-in hysteresis of 0.6 to 1.6 Volts for all models will not allow the converter to restart until the input voltage is sufficiently reduced.

Start-Up Time

The V_{IN} to V_{OUT} start-up time is the interval of time where the input voltage crosses the turn-on threshold point, and the fully loaded output voltage enters and remains within its specified accuracy band. Actual measured times will vary with input source impedance, external input/output capacitance, and the slew rate of the input voltages. The XWR 15 Watt Series implements a soft start circuit that limits the duty cycle of the PWM controller at power up, thereby limiting the Input Inrush current.

The On/Off Control to V_{OUT} start-up time assumes the converter has its nominal input voltage applied but is turned off via the On/Off Control pin. The specification defines the interval between the time at which the converter is turned on and the fully loaded output voltage enters and remains within its specified accuracy band. Similar to the V_{IN} to V_{OUT} start-up, the On/Off Control to V_{OUT} start-up time is also governed by the internal soft start circuitry and external load capacitance.

On/Off Control

The On/Off Control (pin 3) may be used for remote on/off operation. As shown in Figure 1, the control pin is referenced to the -Input (pin 2) and will be internally pulled to a high state. The XWR Series is designed so that it is enabled when the control pin is left open (pulled high) and disabled when the control pin is pulled low (less than +0.8V relative to -Input).

Dynamic control of the on/off function is best accomplished with a mechanical relay or an open-collector/open-drain circuit (optically isolated if appropriate). The drive circuit should be able to sink approximately 1 mA for logic low.

The on/off control function is designed such that the converter can be disabled while the input power is ramping up, and then "released" once the input has stabilized.

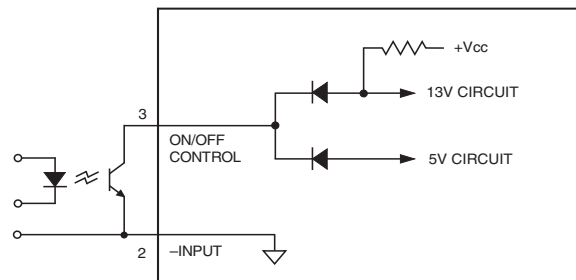

Figure 2. Internal On/Off Control circuitry

5V & 3.3V Regulation

The XWR Series converters are designed such that both the 5V and 3.3V outputs share a common regulation feedback control loop. Though the feedback loop is influenced by both outputs, the 3.3 Volt output is dominant. As a result, the 3.3 Volt regulation (0.5%) is superior to the 5 Volt regulation (1.5%).

The converters are specified for load regulation of minimum (250mA) to 100% loading. All models are stable under no-load conditions, but operation below minimum load mandates an increase in the regulation tolerance of $\pm 0.5\%$ for 3.3 Volt output and an increase of $\pm 1\%$ for the 5 Volt output. A slight increase in switching noise may also be observed for operation below minimum loading. Operation with a full load on 3.3 Volt output and light to no load on 5 Volt output is the most demanding for +5V regulation.

Filtering and Noise Reduction

The XWR Series Converters achieve their rated ripple and noise specifications with the use of 0.47 μ F ceramic in parallel with 100 μ F tantalum output capacitors. In critical applications, input/output noise may be further reduced by installing additional external I/O capacitors. Input capacitors should be selected for bulk capacitance, low ESR and high rms-ripple-current ratings. Output capacitors should be selected for low ESR and appropriate frequency response. All caps should have appropriate voltage ratings and be located as close to the converter as possible.

Thermal Shutdown

These XWR converters are equipped with Thermal Shutdown Circuitry. If the internal temperature of the DC/DC converter rises above the designed operating temperature, a precision temperature sensor will power down the unit. When the internal temperature decreases below the threshold of the temperature sensor, the units will self start.

Current Limiting

When power demands from either output fall within 120% to 190% of the rated output current, the DC/DC converter will go into a current limiting mode. In this condition, both output voltages will decrease proportionately with increases in output current, thereby maintaining a somewhat constant power dissipation.

This is commonly referred to as power limiting. Current limit inception is defined as the point where the full-power output voltage falls below the specified tolerance. If the load current being drawn from the converter is significant enough, the unit will go into a short circuit condition. See "Short Circuit Condition."

Short Circuit Condition

When a converter is in current limit mode the output voltages will drop as the output current demand increases. If the output voltage drops too low, the magnetically coupled voltage used to develop primary side voltages will also drop, thereby shutting down the PWM controller.

Following a time-out period of 5 to 15 milliseconds, the PWM will restart, causing the output voltages to begin ramping to their appropriate values. If the short-circuit condition persists, another shutdown cycle will be initiated. This on/off cycling is referred to as "hiccup" mode. The hiccup cycling reduces the average output current, thereby preventing internal temperatures from rising to excessive levels. The modules are capable of enduring an indefinite short circuit output condition.

Trimming Output Voltages

The DSM/DWR converters have a trim capability (pin 9) that allow users to adjust the output voltages $\pm 5\%$. A trim adjustment will cause an equal percentage of change in both outputs. Adjustments to the output voltages can be accomplished via a trim pot, Figure 3, or a single fixed resistor as shown in Figures 4 and 5. A single fixed resistor can increase or decrease the output voltage depending on its connection. Fixed resistors should have absolute TCR's less than 100ppm/ $^{\circ}$ C to minimize sensitivity to changes in temperature.

A single resistor connected from the Trim pin (pin 9) to the +3.3V Output (pin 8), see Figure 4, will decrease the output voltages. A resistor connected from the Trim pin (pin 9) to Output Return (pin 7) will increase the output voltages.

Trim adjustments greater than 5% can have an adverse effect on the converter's performance and is not recommended.

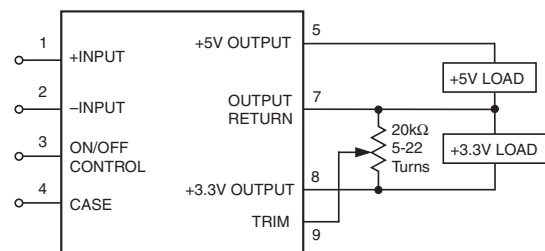
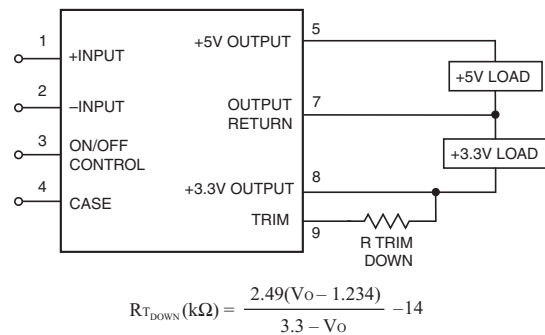
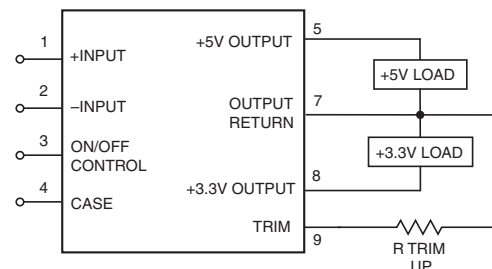

Figure 3. Trim Connections Using A Trimpot



$$R_{T\text{DOWN}} (\text{k}\Omega) = \frac{2.49(V_o - 1.234)}{3.3 - V_o} - 14$$

Figure 4. Decrease Output Voltage Trim Connections Using A Fixed Resistor



$$R_{T\text{UP}} (\text{k}\Omega) = \frac{3.073}{V_o - 3.3} - 14$$

Figure 5. Increase Output Voltage Trim Connections Using A Fixed Resistor

Accuracy of adjustment is subject to tolerances or resistor values and factory-adjusted output accuracy. V_o = desired output voltage.

Recommended PC Board Layout

A single pc board layout could accommodate both the through-hole and the SMT models of the XWR Series as per the figure below. Note that on page 2 of this data sheet, the DWR through-whole package is drawn with a bottom view of its pin locations, and the DSM surface-mount package is drawn with a top view of its pin locations. As shown, the through-hole pin locations, when viewed from the top, fall just aside (on 1.8 inch centers) the SMT pin locations, which essentially begin on 2.1 inch centers.

The layout shows +Input and Case grounded on the primary side. Application dependant the primary ground could of course also be connected to -Input and Case. Creepage and clearance distances between input and output should comply with all relevant safety regulations.

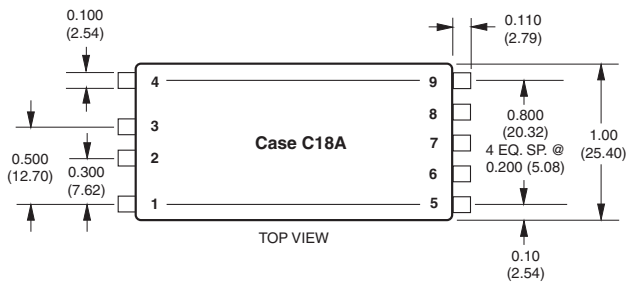
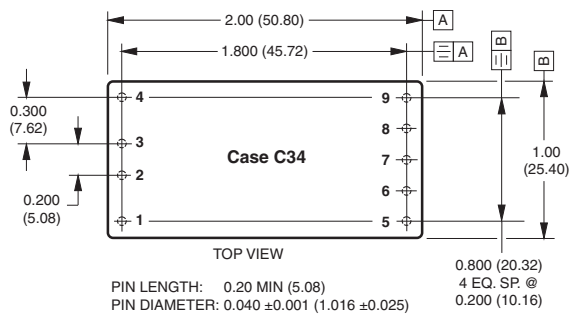

I/O Connections	
Pin	Function P36
1	+Input
2	-Input
3	On/Off Control
4	Case
5	+5V Output
6	NC
7	Output Return
8	+3.3V Output
9	Trim

Figure 6. Recommended Board Layout

SMT Solder Process for DSM models

For the surface-mount DSM models of the XWR Series, the packages' gull-wing leads are made of tin-plated (150 micro inches) copper. The gull-wing configuration, as opposed to "J" leads, was selected to keep the solder joints out from under the package to minimize both, heat conduction away from the leads (into the encapsulated package) and shadowing effects.

DSM modules do not currently withstand the standard solder-reflow process with its most common temperature profiles. In order to avoid damage to the converter a selective solder process with the following parameters must therefore be chosen (i.e. hot air gun or a hand soldering method):

Pre-heat phase 30-60°C rise/minute to 150°C maximum.

Lead temperature 300°C for 10 seconds maximum.

As shown in Figure 7, our tests have determined the optimal landing-pad size to be 160 mils by 130 mils (4 x 3.3 mm).

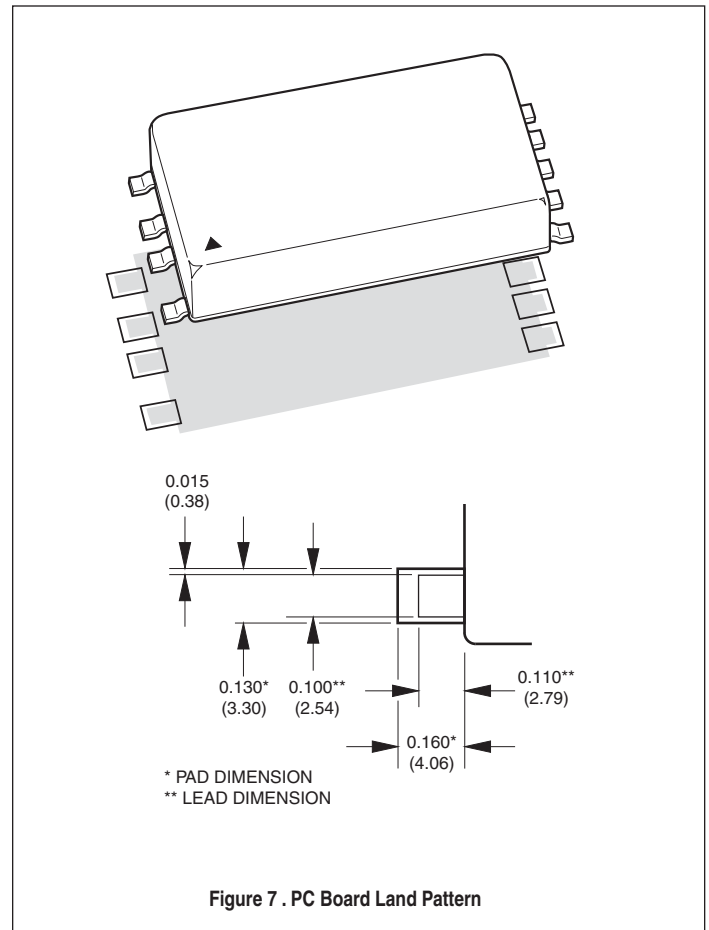

PERFORMANCE DATA

D12 Models

DSM-5/2.65-3.3/3-D12 - Typical 3.3 V_{OUT} Efficiency vs. Load (+5V @ 250mA)

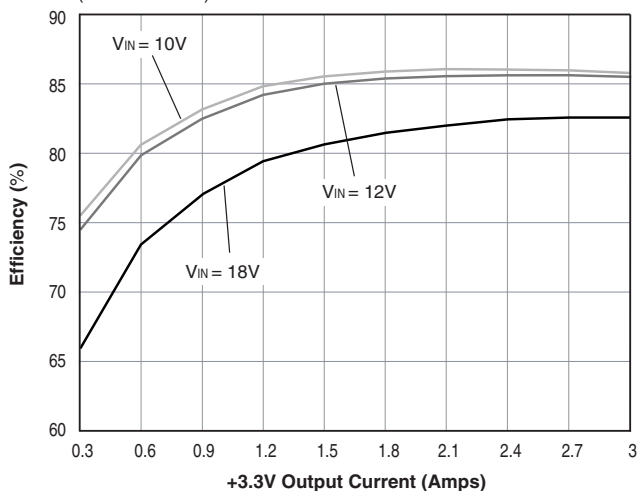

D24 Models

DSM-5/2.65-3.3/3-D24 - Typical 3.3 V_{OUT} Efficiency vs. Load (+5V @ 250mA)

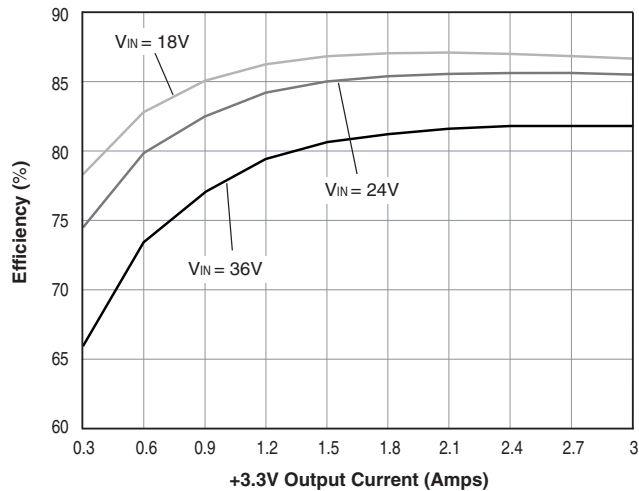

DSM-5/2.65-3.3/3-D12 - Typical 5 V_{OUT} Efficiency vs. Load (+3.3V @ 250mA)

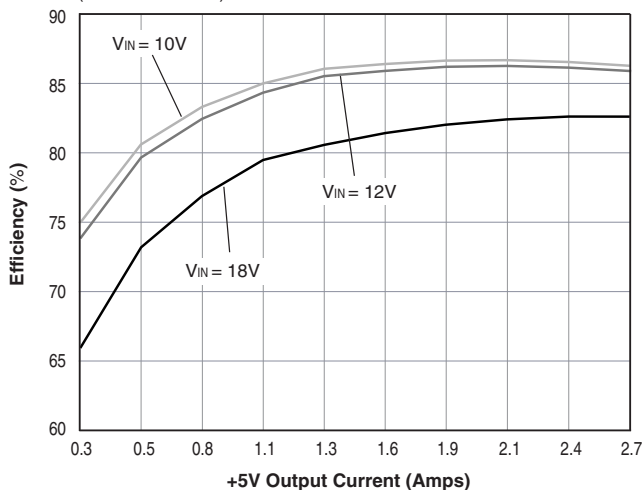

DSM-5/2.65-3.3/3-D24 - Typical 5 V_{OUT} Efficiency vs. Load (+3.3V @ 250mA)

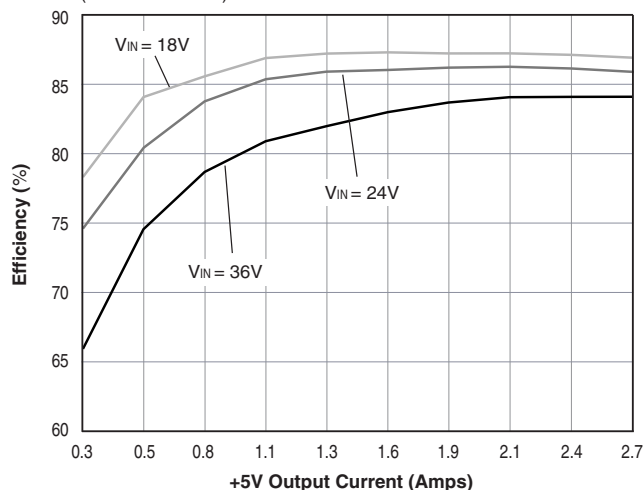

DSM-5/2.65-3.3/3-D12 - Efficiency vs. Line and Load

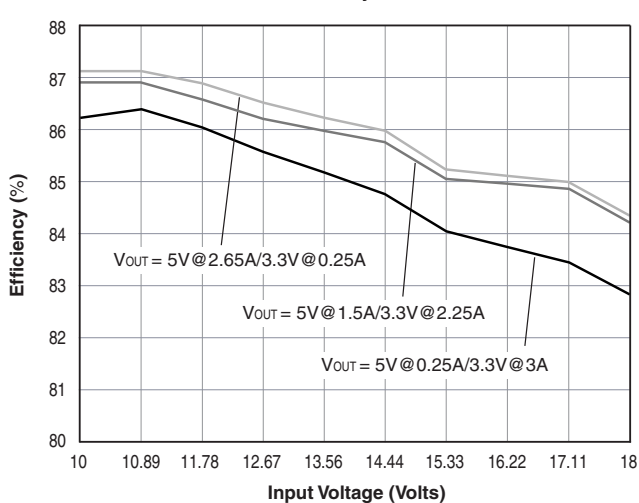

DSM-5/2.65-3.3/3-D24 - Efficiency vs. Line and Load

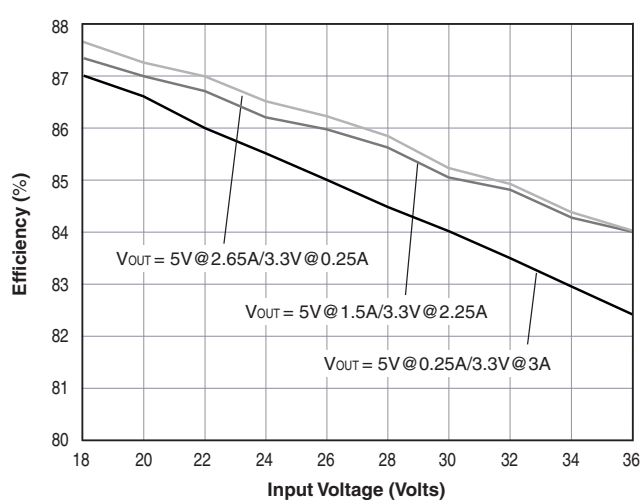

PERFORMANCE DATA

D48 Models

DSM-5/2.65-3.3/3-D48 - Typical 3.3V V_{OUT} Efficiency vs. Load
(+5V @ 250mA)

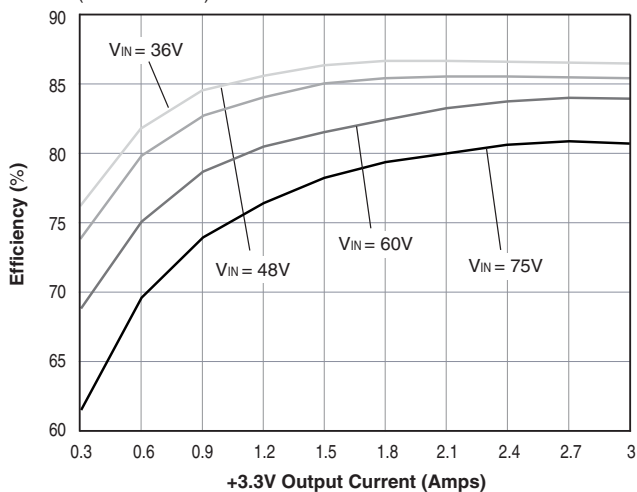

D12, 24, 48 Models

Output Power vs. Ambient Temperature
 V_{IN} = Nominal, Natural Convection

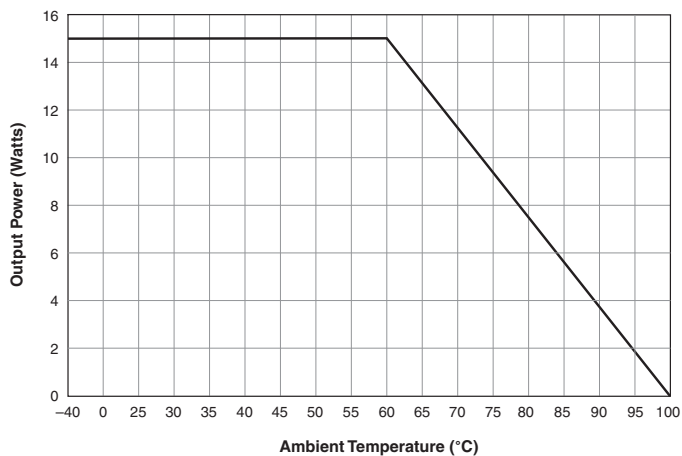

DSM-5/2.65-3.3/3-D48 - Typical 5V V_{OUT} Efficiency vs. Load
(+3.3V @ 250mA)

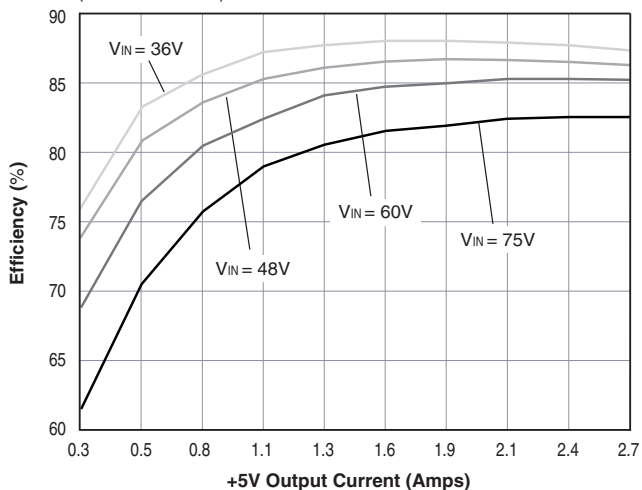

Start-Up from V_{IN}

(V_{IN} = nominal, 5V @ 1.5A/3.3V @ 2.25A, 0.47 μ F || 100 μ F tantalum output capacitors.)

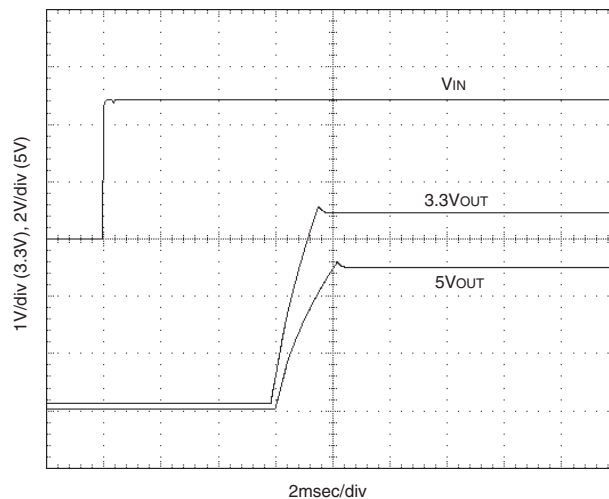

DSM-5/2.65-3.3/3-D48 - Efficiency vs. Line and Load

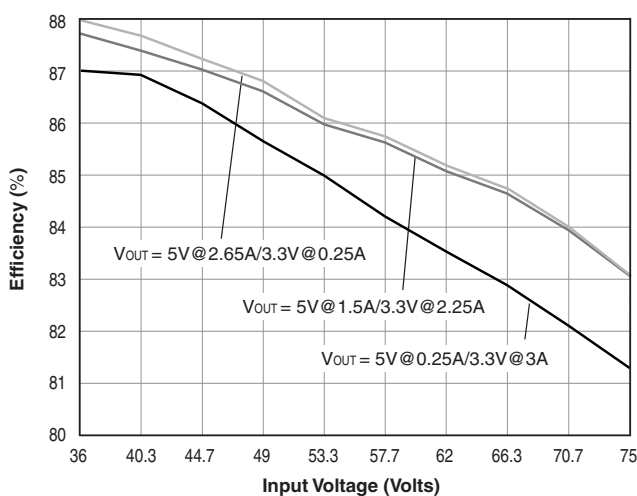

Murata Power Solutions, Inc.
11 Cabot Boulevard, Mansfield, MA 02048-1151 U.S.A.
ISO 9001 and 14001 REGISTERED



**This product is subject to the following [operating requirements](#) and the [Life and Safety Critical Application Sales Policy](#):
Refer to: <http://www.murata-ps.com/requirements/>**

Murata Power Solutions, Inc. makes no representation that the use of its products in the circuits described herein, or the use of other technical information contained herein, will not infringe upon existing or future patent rights. The descriptions contained herein do not imply the granting of licenses to make, use, or sell equipment constructed in accordance therewith. Specifications are subject to change without notice.
© 2014 Murata Power Solutions, Inc.