



FEATURES

- Single isolated output
- 1kVDC Isolation “Hi Pot Test”
- Typical efficiency 86%
- Wide temperature performance at full 1 Watt load, -40°C to 85°C
- UL 60950 recognised
- 3.3V, 5V, 12V, 15V & 24V Input
- 3.3V, 5V, 9V, 12V & 15V Output
- Internal SMD construction
- Toroidal magnetics

PRODUCT OVERVIEW

The MTE1 series is a new range of surface mount, high performance 1W DC-DC converters. The MTE1 series is the new high performance version of our 1W NTE series, the MTE1 series is more efficient and offers improved regulation performance. The MTE1 series offers 1W of available output power over the full industrial temperature range of -40°C to 85°C.

The MTE1 series has a MSL rating 1, and is compatible with a peak reflow solder temperature of 245°C as per J-STD-020D.1.

SELECTION GUIDE

Order Code ¹	Nominal Input Voltage	Output Voltage	Output Current	Input Current at Rated Load (Typ.)	Load Regulation (Typ.)	Load Regulation (Max)	Output Ripple & Noise (Typ.)	Efficiency (Min.)	Efficiency (Typ.)	Isolation Capacitance	MTTF
	V	V	mA	mA	%	%	mVp-p	%	%	pF	kHrs
MTE1S0303MC	3.3	3.3	303	382	11	13.5	33	75	78	15	3083
MTE1S0305MC	3.3	5	200	363	8.5	11	24	79	82	16	2912
MTE1S0309MC	3.3	9	111	353	7	9	17	82	85	21	2759
MTE1S0312MC	3.3	12	83	348	6.5	8	15	83	86	20	2573
MTE1S0315MC	3.3	15	67	346	6	8	13	83	86	20	2265
MTE1S0503MC	5	3.3	303	248	9	12	24	77	79	21	3080
MTE1S0505MC	5	5	200	239	6.5	8	20	79	82	22	3041
MTE1S0506MC	5	6	167	236	6	7.5	20	81	84	24	3024
MTE1S0509MC	5	9	111	233	5	6.5	15	83	85	26	2875
MTE1S0512MC	5	12	83	227	5	6.5	14	84	87	29	2658
MTE1S0515MC	5	15	67	225	5	6.5	11	85	88	33	2336
MTE1S1205MC	12	5	200	97	5	7	19	81	84	24	2707
MTE1S1209MC	12	9	111	95	3	4.5	13	82	86	29	2597
MTE1S1212MC	12	12	83	93	3	4.5	12	85	88	43	2422
MTE1S1215MC	12	15	67	93	3	4	11	85	88	40	2169
MTE1S1505MC	15	5	200	79	4	5.5	15	80	83	25	2444
MTE1S1509MC	15	9	111	77	3	4	9	81	86	38	2366
MTE1S1512MC	15	12	83	76	2.5	4	10	82	87	45	2196
MTE1S1515MC	15	15	67	75	2.5	4	8	84	88	57	2001
MTE1S2405MC	24	5	200	50	4	5.5	20	79	83	21	2731
MTE1S2409MC	24	9	111	48	2.5	4	19	84	86	31	2698
MTE1S2412MC	24	12	83	48	2	3.5	19	83	87	39	2488
MTE1S2415MC	24	15	67	48	2	3.5	22	85	88	46	2392

INPUT CHARACTERISTICS

Parameter	Conditions	Min.	Typ.	Max.	Units
Voltage range	Continuous operation, 3.3V input types	2.97	3.3	3.63	V
	Continuous operation, 5V input types	4.5	5.0	5.5	
	Continuous operation, 12V input types	10.8	12.0	13.2	
	Continuous operation, 15V input types	13.5	15.0	16.5	
	Continuous operation, 24V input types	21.6	24	26.4	
Reflected ripple current			5	15	mA p-p

ISOLATION CHARACTERISTICS

Parameter	Conditions	Min.	Typ.	Max.	Units
Isolation voltage	Flash tested for 1 second	1000			VDC
Resistance	Viso= 1000VDC	20			GΩ

GENERAL CHARACTERISTICS

Parameter	Conditions	Min.	Typ.	Max.	Units
Switching frequency	All output types		80		Hz

ABSOLUTE MAXIMUM RATINGS

Input voltage V_{in} , MTE03 types	5.5V
Input voltage V_{in} , MTE05 types	7V
Input voltage V_{in} , MTE12 types	15V
Input voltage V_{in} , MTE15 types	18V
Input voltage V_{in} , MTE24 types	28V

1. If components are required in tape and reel format suffix order code with -R, e.g. MTE0505MC-R.

2. Calculated using MIL-HDBK-217 FN2 calculation model with nominal input voltage at full load.

All specifications typical at $T_A=25^\circ\text{C}$, nominal input voltage and rated output current unless otherwise specified.



For full details go to
www.murata-ps.com/rohs



OUTPUT CHARACTERISTICS

Parameter	Conditions	Min.	Typ.	Max.	Units
Rated power	T _A =-40°C to 85°C			1.0	W
Voltage set point accuracy	See tolerance envelope				
Line regulation	High V _{IN} to low V _{IN}		1.1	1.2	%/%
Ripple and noise	BW=DC to 20MHz		25	70	mV p-p

TEMPERATURE CHARACTERISTICS

Parameter	Conditions	Min.	Typ.	Max.	Units
Specification	All output types	-40		85	°C
Storage		-50		130	
Case temperature rise above ambient	All output types		12.5	20	
Cooling	Free air convection				

TECHNICAL NOTES

ISOLATION VOLTAGE

'Hi Pot Test', 'Flash Tested', 'Withstand Voltage', 'Proof Voltage', 'Dielectric Withstand Voltage' & 'Isolation Test Voltage' are all terms that relate to the same thing, a test voltage, applied for a specified time, across a component designed to provide electrical isolation, to verify the integrity of that isolation.

Murata Power Solutions MTE1 series of DC/DC converters are all 100% production tested at their stated isolation voltage. This is 1kVDC for 1 second.

A question commonly asked is, "What is the continuous voltage that can be applied across the part in normal operation?"

The MTE1 has been recognized by Underwriters Laboratory for functional insulation, both input and output should normally be maintained within SELV limits i.e. less than 42.4V peak, or 60VDC. The isolation test voltage represents a measure of immunity to transient voltages and the part should never be used as an element of a safety isolation system. The part could be expected to function correctly with several hundred volts offset applied continuously across the isolation barrier; but then the circuitry on both sides of the barrier must be regarded as operating at an unsafe voltage and further isolation/insulation systems must form a barrier between these circuits and any user-accessible circuitry according to safety standard requirements.

REPEATED HIGH-VOLTAGE ISOLATION TESTING

It is well known that repeated high-voltage isolation testing of a barrier component can actually degrade isolation capability, to a lesser or greater degree depending on materials, construction and environment. The MTE1 series has toroidal isolation transformers, with no additional insulation between primary and secondary windings of enameled wire. While parts can be expected to withstand several times the stated test voltage, the isolation capability does depend on the wire insulation. Any material, including this enamel (typically polyurethane) is susceptible to eventual chemical degradation when subject to very high applied voltages thus implying that the number of tests should be strictly limited. We therefore strongly advise against repeated high voltage isolation testing, but if it is absolutely required, that the voltage be reduced by 20% from specified test voltage.

This consideration equally applies to agency recognized parts rated for better than functional isolation where the wire enamel insulation is always supplemented by a further insulation system of physical spacing or barriers.

SAFETY APPROVAL

The MTE1 series has been recognized by Underwriters Laboratory (UL) to UL 60950 for functional insulation in a maximum ambient temperature for 3.3V & 5V input models of 60°C and for 12V, 15V and 24V models of 85°C. File number E151252 applies. The MTE1 Series of converters are not internally fused so to meet the requirements of UL 60950 an anti-surge input line fuse should always be used with ratings as defined below.

- MTE1S03xxxC: 1A
- MTE1S05xxxC: 0.7A
- MTE1S12xxxC: 0.2A
- MTE1S15xxxC: 0.2A
- MTE1S24xxxC: 0.16A

All fuses should be UL approved and rated to at least the maximum allowable DC input voltage.

TEMPERATURE DERATING GRAPH

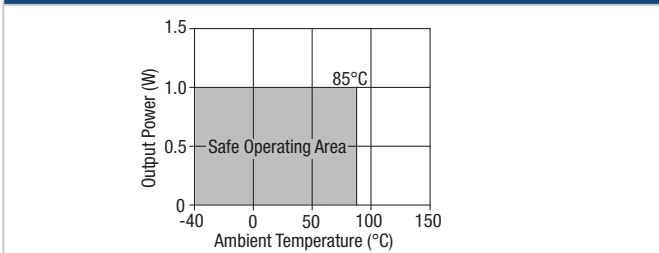

TOLERANCE ENVELOPES

The voltage tolerance envelope shows typical load regulation characteristics for this product series. The tolerance envelope is the maximum output voltage variation due to changes in output loading.

0303, 0503

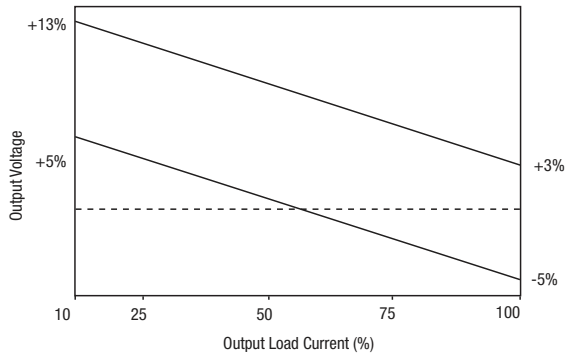

0305, 0309

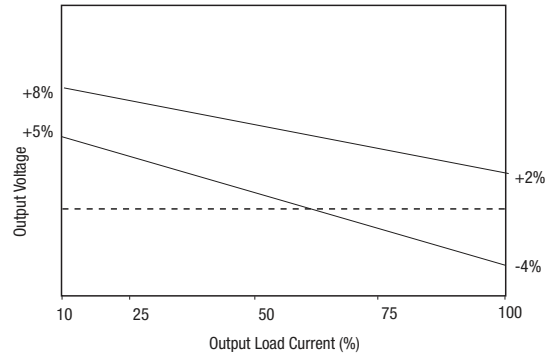

0312, 0315, 0505, 0506, 0509

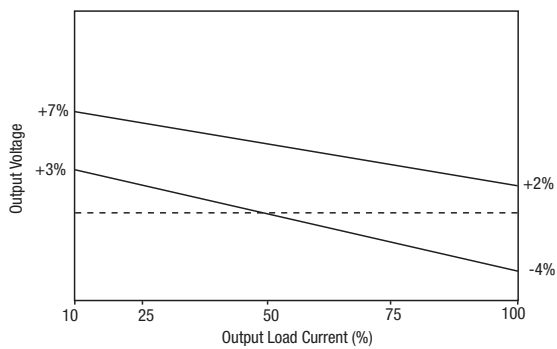

1209, 1212, 1215, 15XX, 2409, 2412, 2415

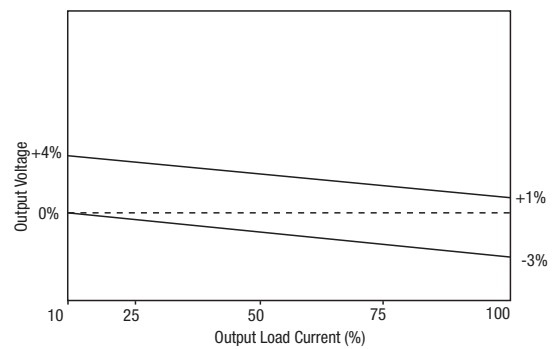

0512, 0515, 1205, 2405

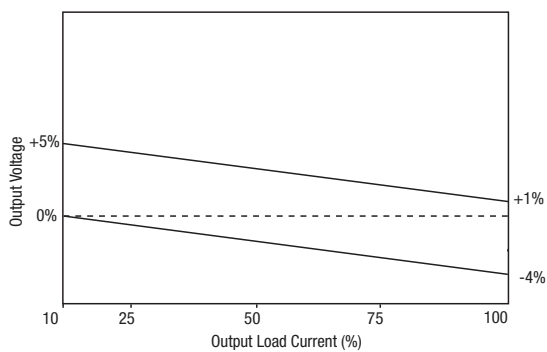

EFFICIENCY VS LOAD

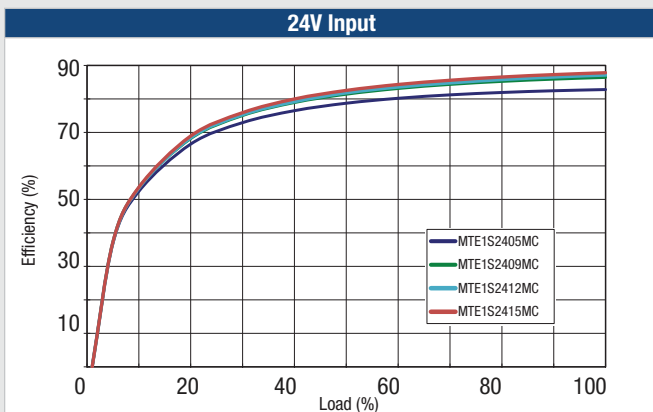
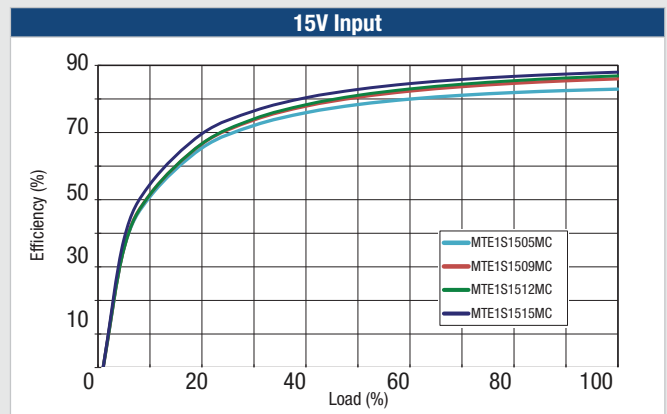
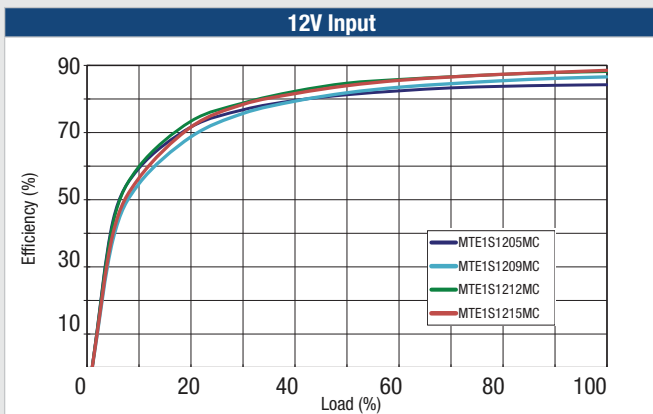
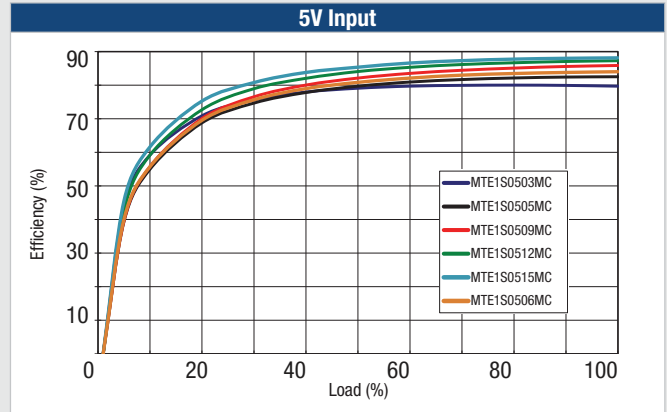
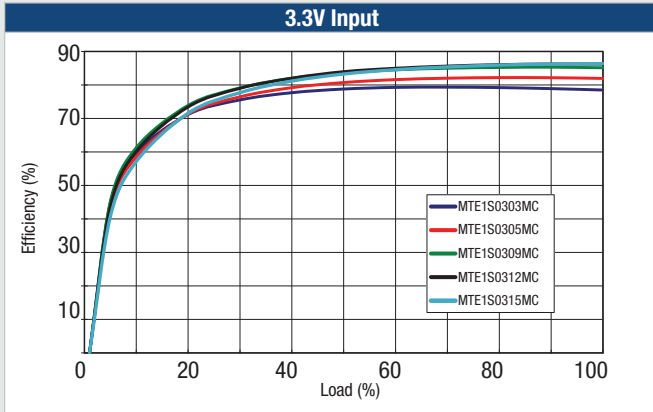

RoHS COMPLIANCE, MSL AND PSL INFORMATION



This series is compatible with RoHS soldering systems with a peak reflow solder temperature of 245°C as per J-STD-020D.1. The pin termination finish on this product series is Matte Tin over Nickel Preplate. The series is backward compatible with Sn/Pb soldering systems. The series has a Moisture Sensitivity Level (MSL) 1.

Samples of the product series were tested in accordance with the conditioning described for MSL level 1 in IDC/J-STD-020D.1. The product series passed electrical tests and visual inspection criteria.

For further information, please visit: www.murata-ps.com/rohs

APPLICATION NOTES

Advisory Notes

The MTE series is not hermetically sealed, customers should ensure that parts are fully dried before input power application.

The MTE has been tested to the following standards, which should not be exceeded for shock and vibration:

- BS EN 60068-2-64:2008 (Vibration Broadband Random)
- BS EN 60068-2-27:2009 (Mechanical Shock)

Minimum Load

The minimum load to meet datasheet specification is 10% of the full rated load across the specified input voltage range. Lower than 10% minimum loading will result in an increase in output voltage, which may rise to typically double the specified output voltage if the output load falls to less than 5%.

Capacitive Loading & Start Up

Typical start up times for this series, with a typical input voltage rise time of 2.2µs and output capacitance of 10µF, are shown in the table below. The product series will start into a capacitance of 47µF with an increased start time, however, the maximum recommended output capacitance is 10µF.

	Start-up time µs		Start-up time µs		Start-up time µs
MTE1S0303MC	TBC	MTE1S0509MC	TBC	MTE1S1509MC	TBC
MTE1S0305MC	TBC	MTE1S0512MC	TBC	MTE1S1512MC	TBC
MTE1S0309MC	TBC	MTE1S0515MC	TBC	MTE1S1515MC	TBC
MTE1S0312MC	TBC	MTE1S1205MC	TBC	MTE1S2405MC	TBC
MTE1S0315MC	TBC	MTE1S1209MC	TBC	MTE1S2409MC	TBC
MTE1S0503MC	TBC	MTE1S1212MC	TBC	MTE1S2412MC	TBC
MTE1S0505MC	TBC	MTE1S1215MC	TBC	MTE1S2415MC	TBC
MTE1S0506MC	TBC	MTE1S1505MC	TBC		

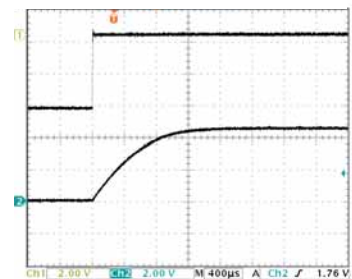

Typical Start-Up Wave Form

Output Ripple Reduction

By using the values of inductance and capacitance stated, the output ripple at the rated load is lowered to 5mV p-p max.

Component selection

Capacitor: It is required that the ESR (Equivalent Series Resistance) should be as low as possible, ceramic types are recommended. The voltage rating should be at least twice (except for 15V output), the rated output voltage of the DC/DC converter.

Inductor: The rated current of the inductor should not be less than that of the output of the DC/DC converter. At the rated current, the DC resistance of the inductor should be such that the voltage drop across the inductor is <2% of the rated voltage of the DC/DC converter. The SRF (Self Resonant Frequency) should be >20MHz.

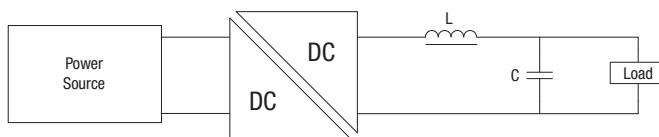

	Inductor			Capacitor
	L, µH	SMD	Through Hole	C, µF
MTE1S0303MC	4.7	82472C	11R472C	10
MTE1S0305MC	10	82103C	11R103C	4.7
MTE1S0309MC	22	82223C	11R223C	2.2
MTE1S0312MC	47	82473C	11R473C	1
MTE1S0315MC	47	82473C	11R473C	1
MTE1S0503MC	4.7	82472C	11R472C	10
MTE1S0505MC	10	82103C	11R103C	4.7
MTE1S0506MC	22	82223C	11R223C	2.2
MTE1S0509MC	22	82223C	11R223C	2.2
MTE1S0512MC	47	82473C	11R473C	1
MTE1S0515MC	47	82473C	11R473C	1
MTE1S1205MC	10	82103C	11R103C	4.7
MTE1S1209MC	22	82223C	11R223C	2.2
MTE1S1212MC	47	82473C	11R473C	1
MTE1S1215MC	47	82473C	11R473C	1
MTE1S1505MC	10	82103C	11R223C	4.7
MTE1S1509MC	22	82223C	11R103C	2.2
MTE1S1512MC	47	82473C	11R473C	1
MTE1S1515MC	47	82473C	11R473C	1
MTE1S2405MC	10	82103C	11R103C	4.7
MTE1S2409MC	22	82223C	11R223C	2.2
MTE1S2412MC	47	82473C	11R473C	1
MTE1S2415MC	47	82473C	11R473C	1

EMC FILTERING AND SPECTRA

FILTERING

A 22uF (100uF for the MTE1S2405MC), input capacitor is required to meet EN 55022 Curve B, Quasi-Peak EMC limit, as shown in the following plots.

MTE1S0303MC

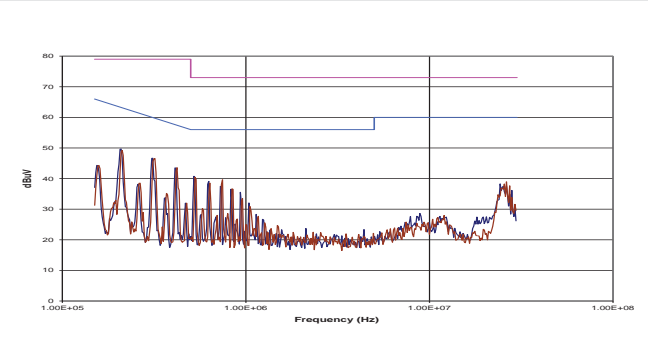

MTE1S0305MC

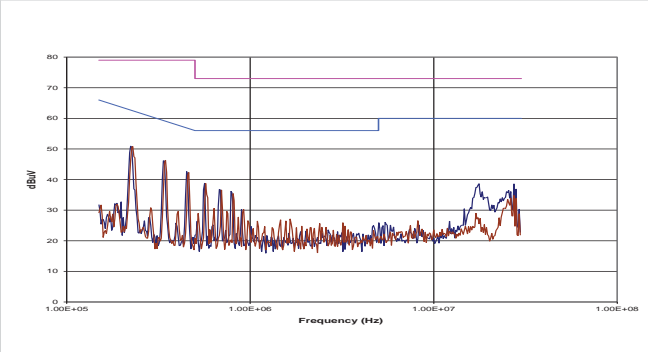

MTE1S0309MC

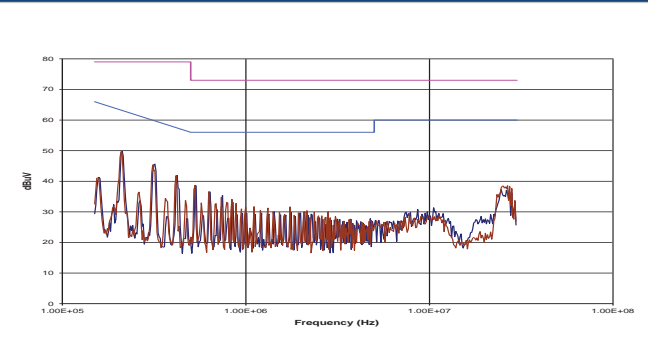

MTE1S0312MC

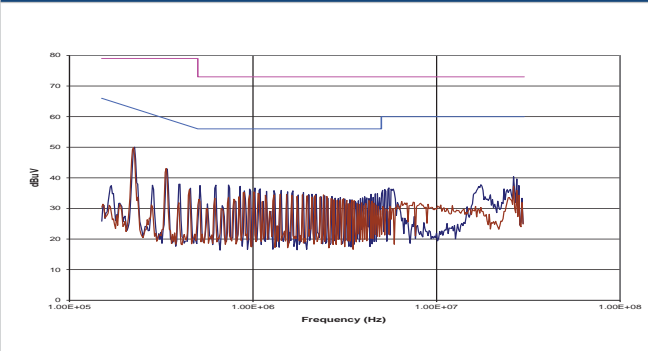

MTE1S0315MC

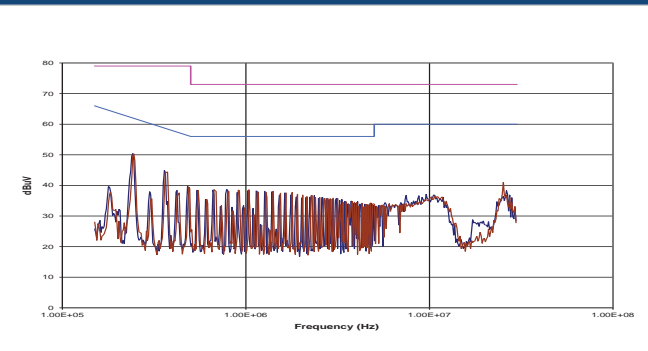

MTE1S0503MC

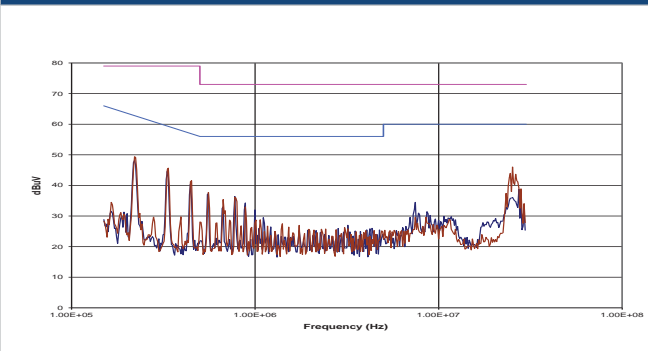

EMC FILTERING AND SPECTRA (continued)

MTE1S0505MC

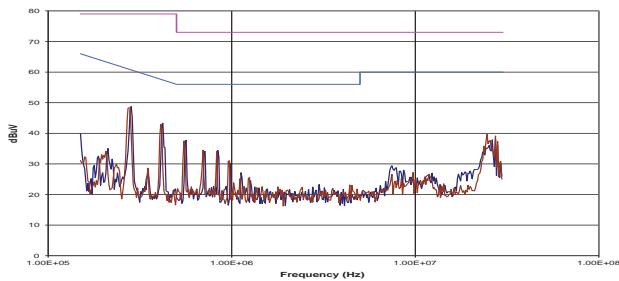

MTE1S0506MC

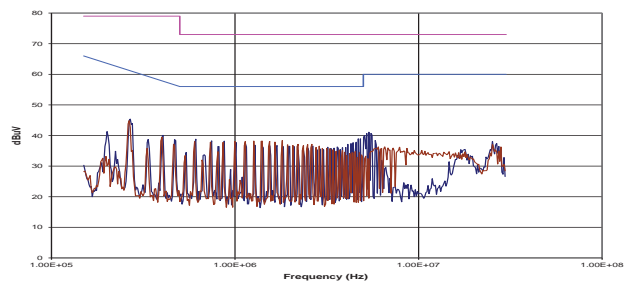

MTE1S0509MC

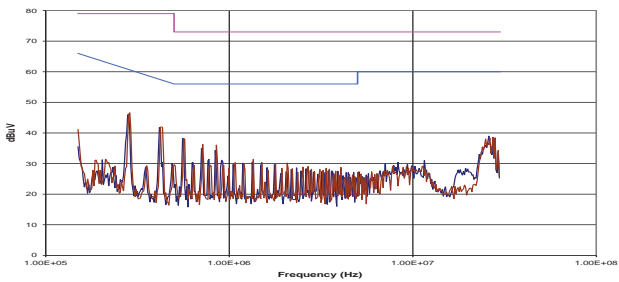

MTE1S0512MC

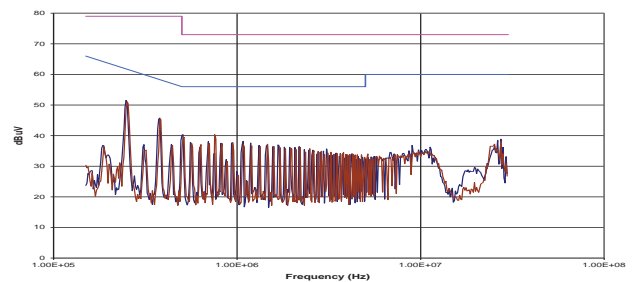

MTE1S0515MC

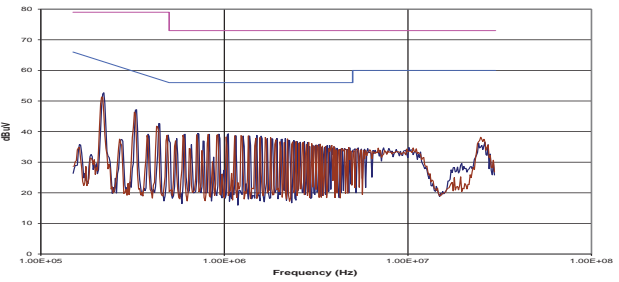

MTE1S1205MC

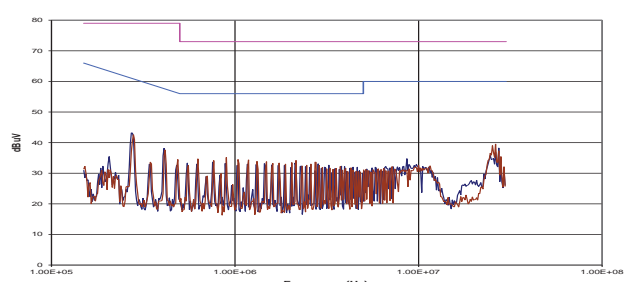

MTE1S1209MC

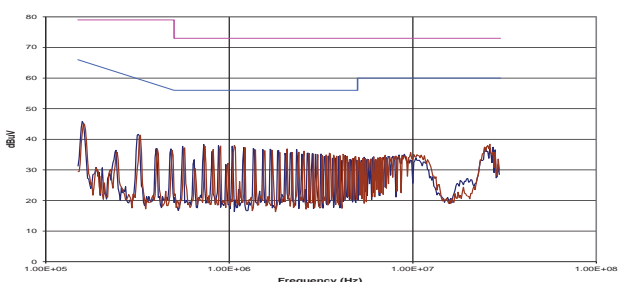

MTE1S1212MC

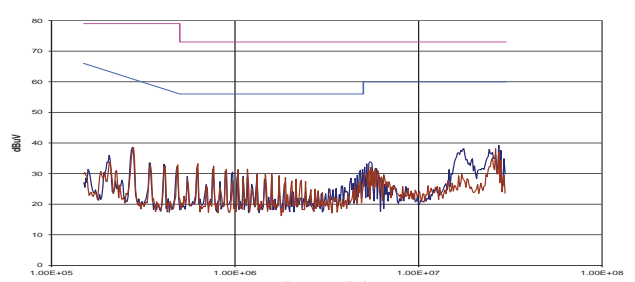

EMC FILTERING AND SPECTRA (continued)

MTE1S1215MC

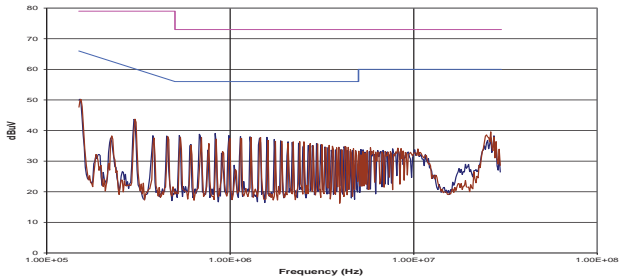

MTE1S1505MC

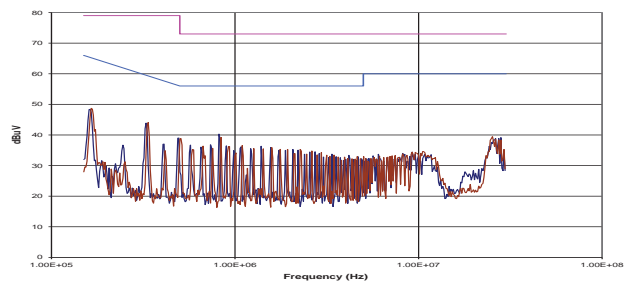

MTE1S1509MC

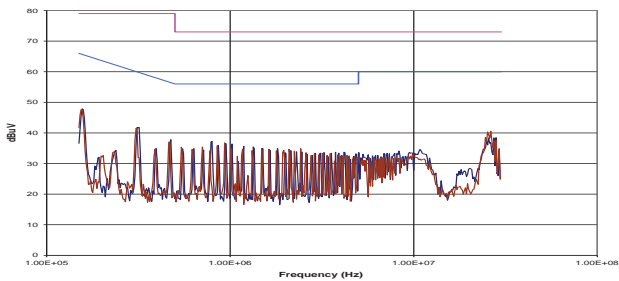

MTE1S1512MC

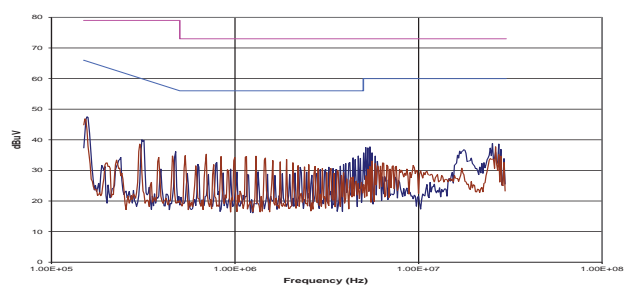

MTE1S1515MC

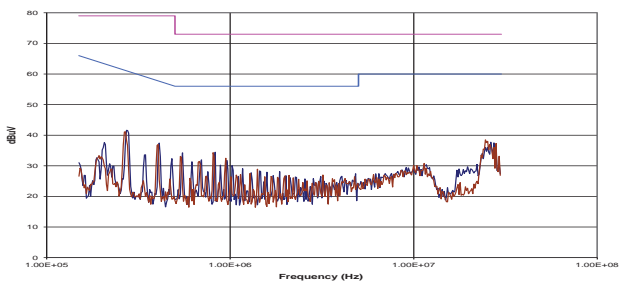

MTE1S2405MC

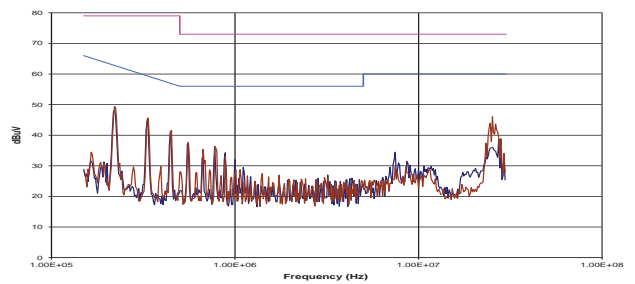

MTE1S2409MC

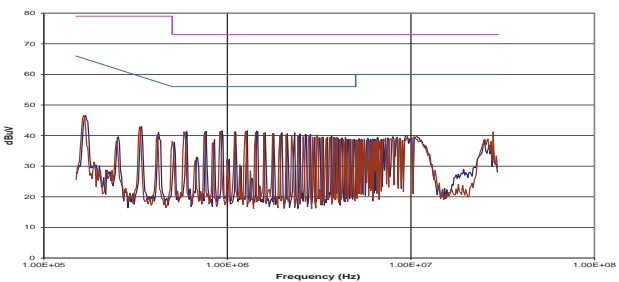

MTE1S2412MC

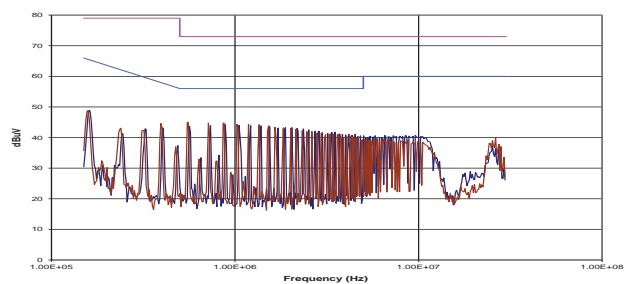

EMC FILTERING AND SPECTRA (continued)

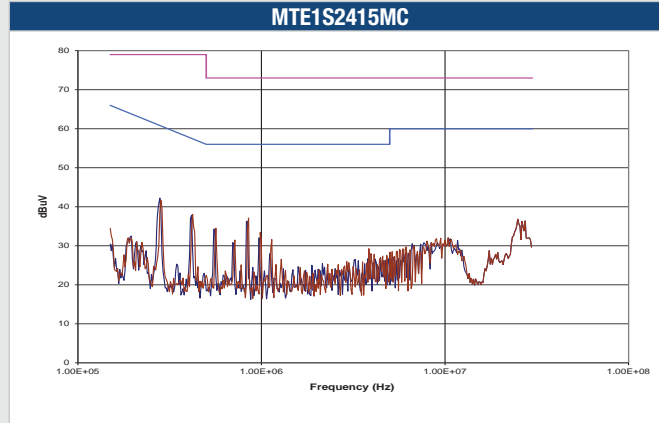

PACKAGE SPECIFICATIONS

Mechanical Dimensions

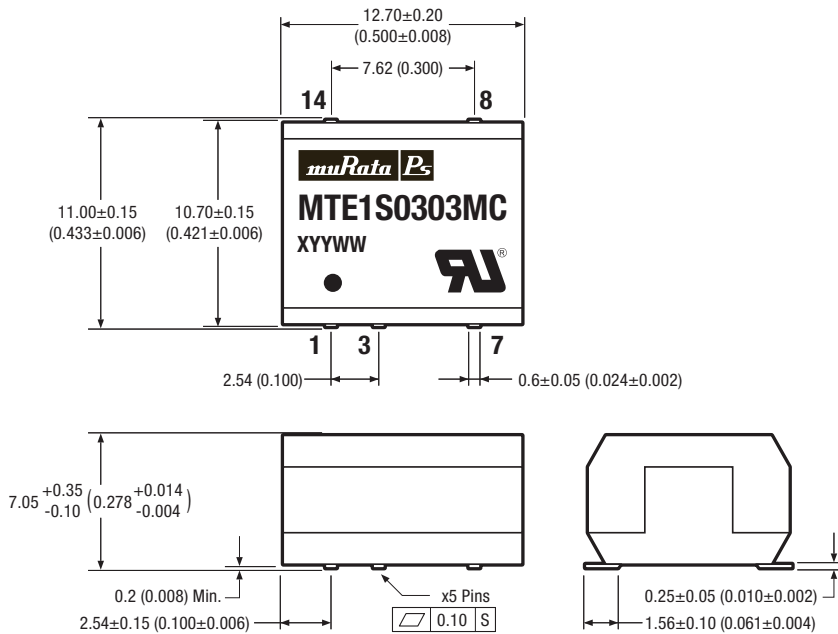

All dimensions in mm ± 0.25 mm (inches ± 0.01). All pins on a 2.54 (0.1) pitch and within ± 0.25 (0.01) of true position.

Weight: 1.1g Typ.

Pin Connections

Pin	Function
1	-V _{IN}
3	+V _{IN}
7	-V _{OUT}
8	+V _{OUT}
14	NA

NA - Not available for electrical connection.

Recommended Footprint Details

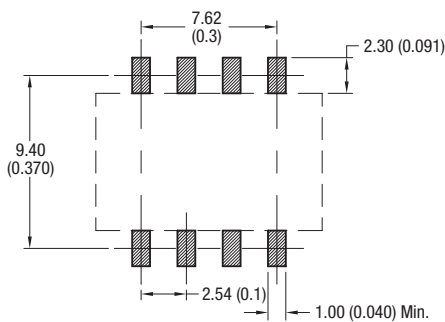

All pins on a 2.54mm pitch.

Tube Outline Dimensions

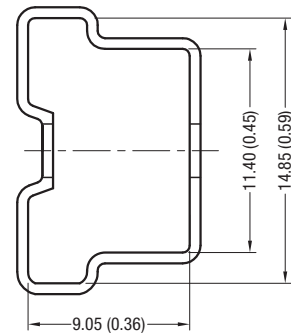

Unless otherwise stated all dimensions in mm ± 0.5 mm (inches ± 0.02).
Tube length : 475 ± 2.0 (18.70 ± 0.07).

Tube Quantity: 30

TAPE & REEL SPECIFICATIONS

REEL OUTLINE DIMENSIONS

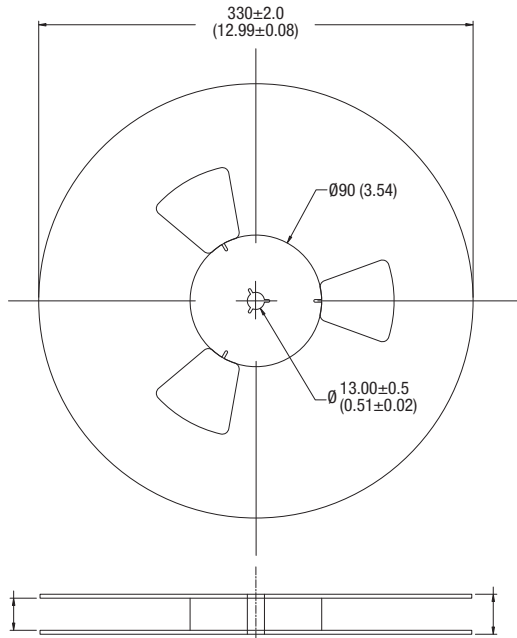

TAPE OUTLINE DIMENSIONS

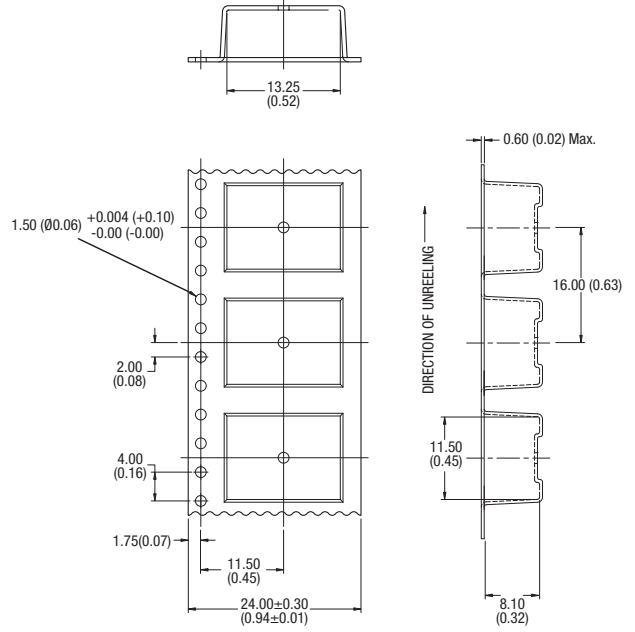

REEL PACKAGING DETAILS

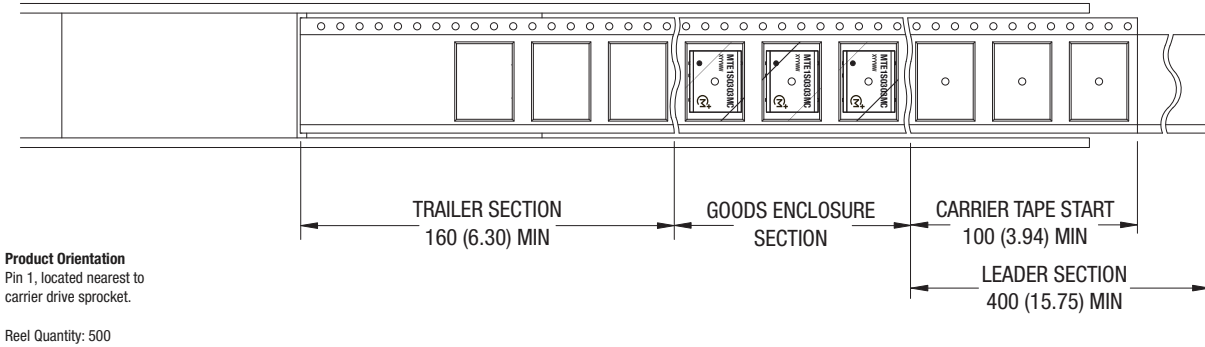

Murata Power Solutions, Inc.
11 Cabot Boulevard, Mansfield, MA 02048-1151 U.S.A.
ISO 9001 and 14001 REGISTERED



This product is subject to the following **operating requirements** and the **Life and Safety Critical Application Sales Policy**:
Refer to: <http://www.murata-ps.com/requirements/>

Murata Power Solutions, Inc. makes no representation that the use of its products in the circuits described herein, or the use of other technical information contained herein, will not infringe upon existing or future patent rights. The descriptions contained herein do not imply the granting of licenses to make, use, or sell equipment constructed in accordance therewith. Specifications are subject to change without notice.
© 2015 Murata Power Solutions, Inc.