

SERIES: V78-1000 | **DESCRIPTION:** NON-ISOLATED SWITCHING REGULATOR

FEATURES

- 1 A current output
- extremely high efficiency up to 97%
- no heat sink required
- pin compatible to LM78XX linear regulators
- available in straight and right angle SIP packages
- low ripple and noise
- short circuit protection, thermal shutdown
- wide temperature (-40~85°C)

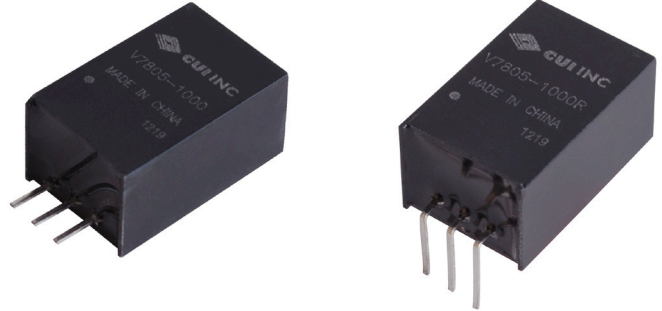

MODEL	input voltage		output voltage ¹ (Vdc)	output current max (mA)	ripple and noise ² max (mVp-p)	efficiency	
	typ (Vdc)	range (Vdc)				Vin min (%)	Vin max (%)
V7803-1000	24	4.75~28	3.3	1,000	35	90	83
V7805-1000	24	6.5~32	5	1,000	35	93	88
V7806-1000	24	9~32	6.5	1,000	35	94	90
V7809-1000	24	12~32	9	1,000	35	95	92
V7812-1000	24	16~32	12	1,000	35	96	94
V7815-1000	24	20~32	15	1,000	35	97	94

Notes: 1. Not recommended for use in a negative output mode.
2. Ripple and noise are measured at 20 MHz BW, see Test Configuration section.

PART NUMBER KEY

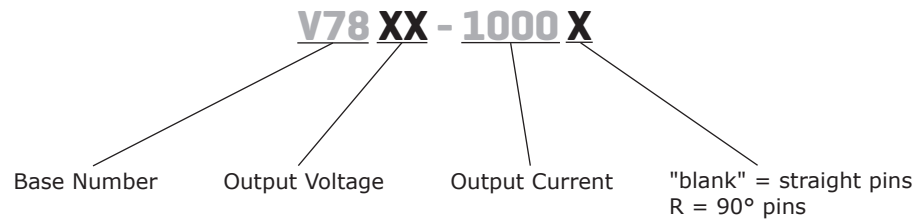

INPUT

parameter	conditions/description	min	typ	max	units
operating input voltage	3.3 Vdc model	4.75	24	28	Vdc
	5 Vdc model	6.5	24	32	Vdc
	6.5 Vdc model	9.0	24	32	Vdc
	9 Vdc model	12	24	32	Vdc
	12 Vdc model	16	24	32	Vdc
	15 Vdc model	20	24	32	Vdc

OUTPUT

parameter	conditions/description	min	typ	max	units
line regulation	Vin = min ~ max, at full load		±0.2	±0.4	%
load regulation	measured from 10% load to full load		±0.4	±0.6	%
voltage accuracy	100% load		±2	±3	%
switching frequency	100% load, input voltage range	280	330	450	kHz
temperature coefficient			±0.02		%/°C
load capacitance				1,000	µF

PROTECTIONS

parameter	conditions/description	min	typ	max	units
short circuit protection	continuous, automatic recovery				
thermal shutdown			150		°C

SAFETY AND COMPLIANCE

parameter	conditions/description	min	typ	max	units
MTBF	as per MIL-HDBK-217F, 25°C	2,000,000			hours
RoHS compliant	2011/65/EU				

ENVIRONMENTAL

parameter	conditions/description	min	typ	max	units
operating temperature	see derating curve	-40		85	°C
storage temperature		-55		125	°C
case temperature				100	°C
storage humidity	non-condensing			95	%
lead temperature	1.5 mm from case for 10 seconds			300	°C

DERATING CURVES

1. output power vs. ambient temperature

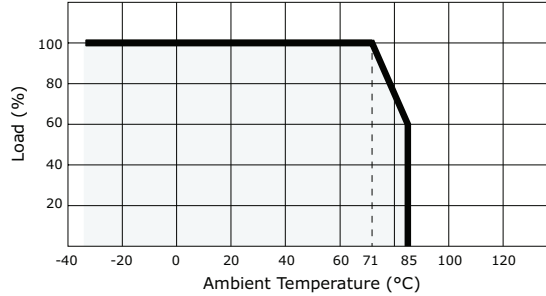

MECHANICAL

parameter	conditions/description	min	typ	max	units
dimensions	11.50 x 9.00 x 17.50 (0.689 x 0.354 x 0.453 inch)				mm
case material	plastic (UL94-V0)				
weight			3.7		g

MECHANICAL DRAWING

units: mm [inches]
 tolerance: ± 0.25 [0.010]
 pin section tolerance: ± 0.10 [0.004]

V78XX-1000

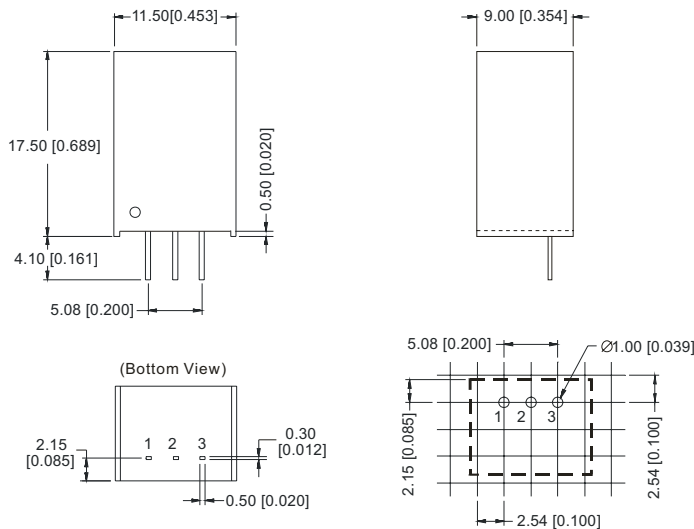

V78XX-1000R

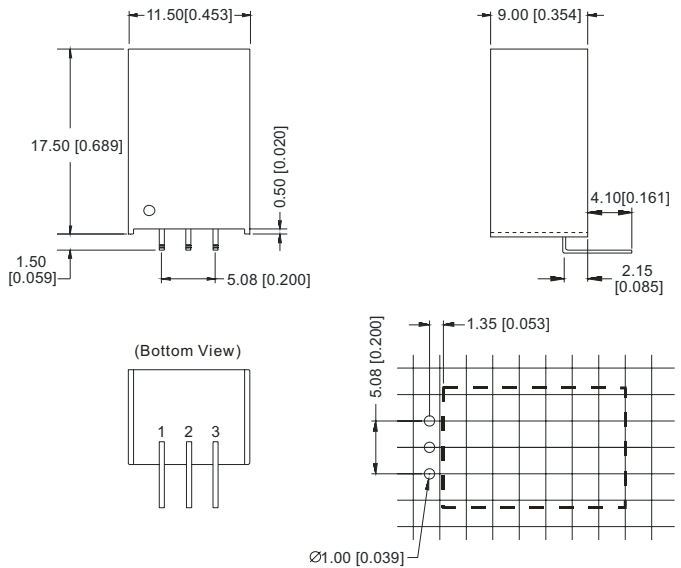

PIN CONNECTIONS	
PIN	FUNCTION
1	+Vin
2	GND
3	+Vo

EXTERNAL CAPACITOR TABLE

Part Number	C1 ² (Ceramic capacitor)	C2 (Ceramic capacitor)
V7803-1000(R)	10µF/50V	22µF/6.3V
V7805-1000(R)	10µF/50V	22µF/16V
V7806-1000(R)	10µF/50V	10µF/16V
V7809-1000(R)	10µF/50V	10µF/16V
V7812-1000(R)	10µF/50V	10µF/25V
V7815-1000(R)	10µF/50V	10µF/25V

TYPICAL APPLICATION CIRCUIT

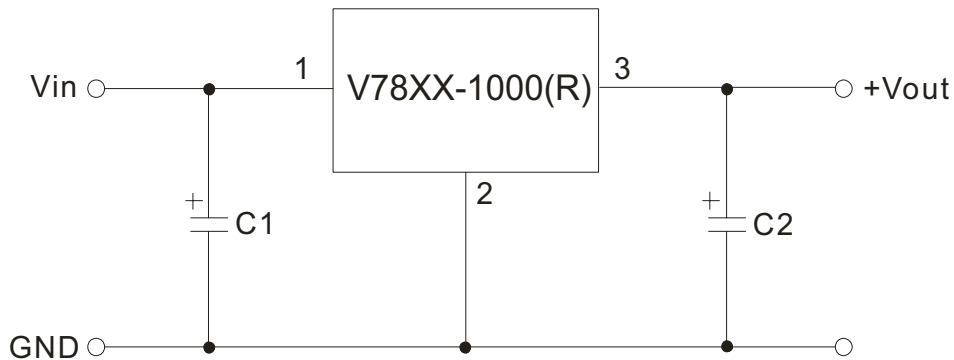

- Notes:
1. C1 and C2 are required and should be fitted close to the converter pins.
 2. If the input voltage is greater than 26 Vdc (3.3 Vdc output model) or greater than 28 Vdc (all other models), it is required to have C1 be $\geq 22 \mu\text{F}$ electrolytic capacitor to protect the part from voltage spikes.

OUTPUT RIPPLE REDUCTION

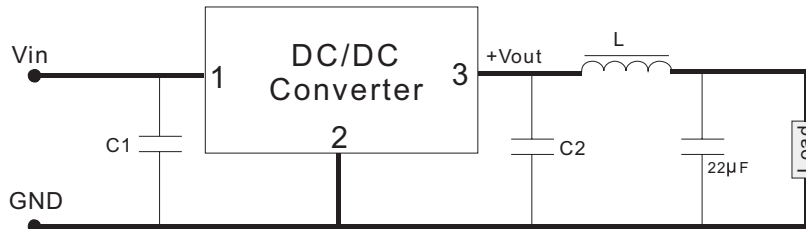

To reduce output ripple, it is recommended to add a LC filter in output port.

L: Recommended parameter $10\mu\text{H} \sim 47\mu\text{H}$.

EFFICIENCY AND RIPPLE CURVES

Efficiency

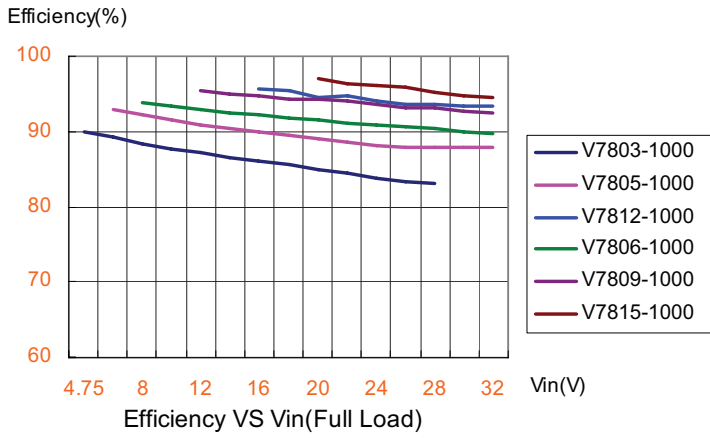

Ripple

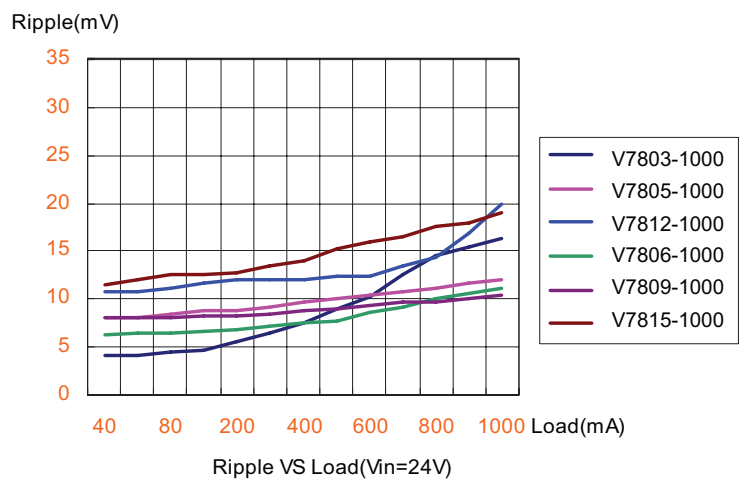
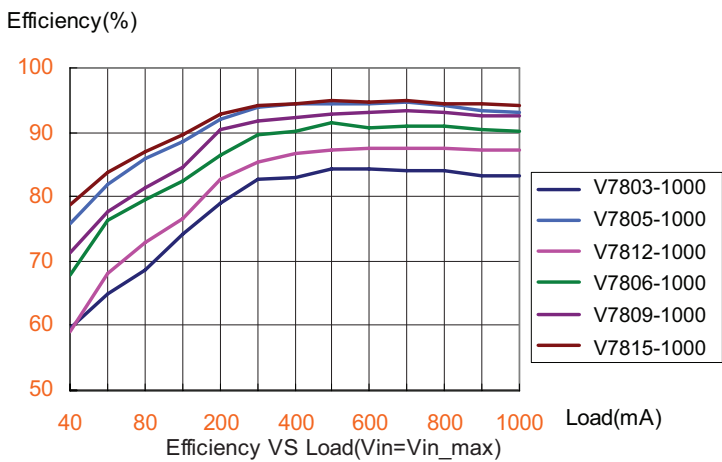
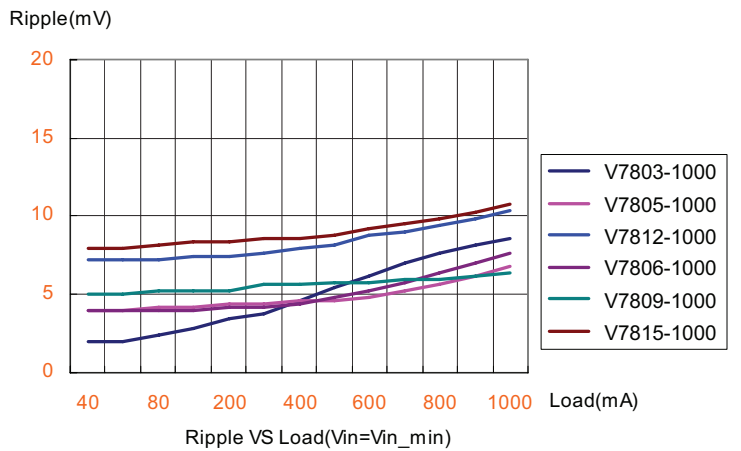
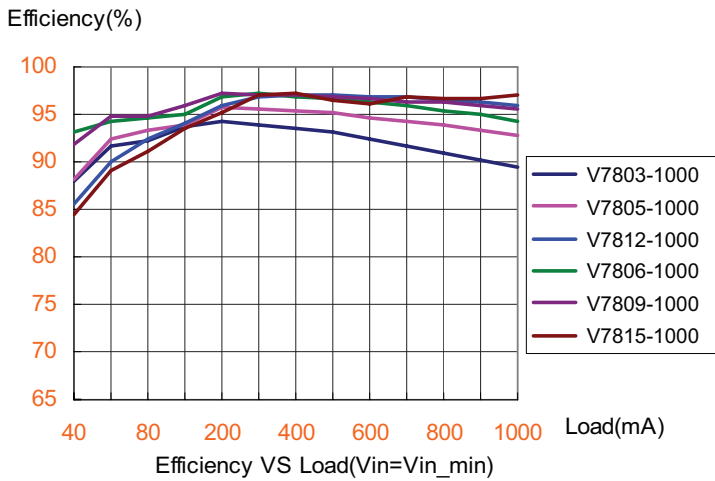
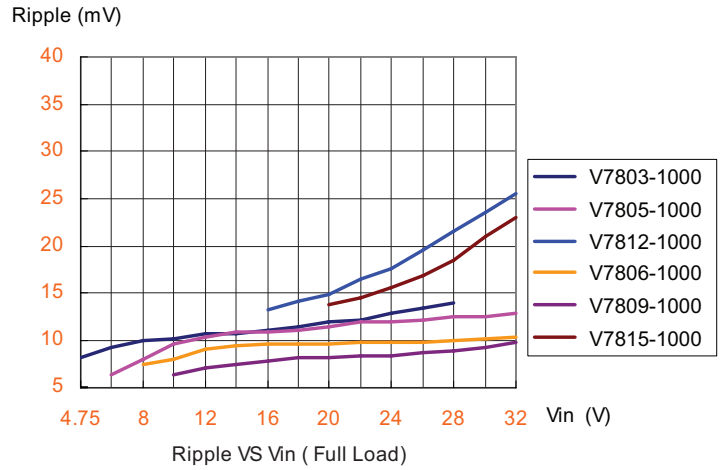

TEST CONFIGURATION

Efficiency and Output Voltage Ripple Test

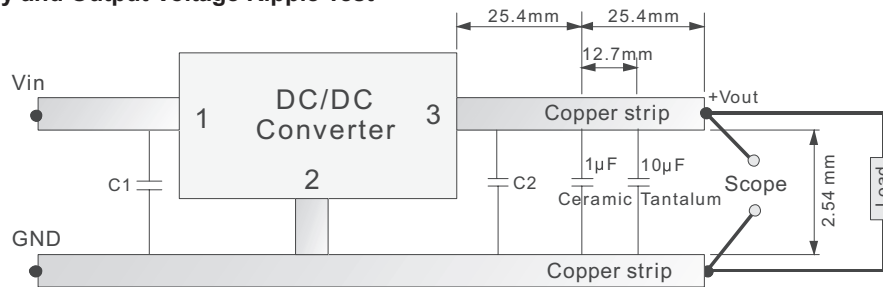

Start-up and Load Transient Response Test

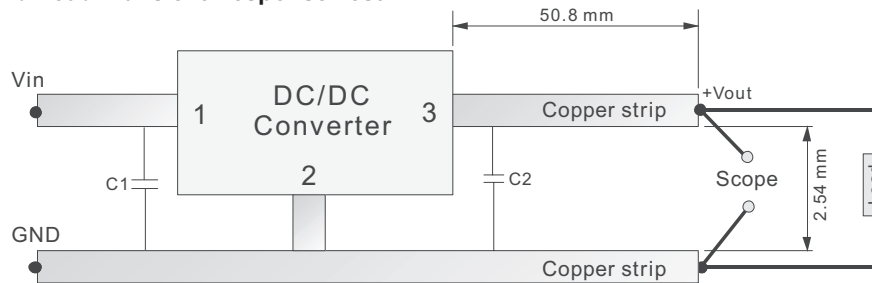

Note: All specifications measured at 25°C, humidity <75%, nominal input voltage, and full load unless otherwise noted.

REVISION HISTORY

rev.	description	date
1.0	initial release	07/13/2010
1.01	V-Infinity branding removed	09/04/2012
1.02	updated typical application circuits	09/25/2012
1.03	corrected switching frequency values	04/22/2013
1.04	not recommended for use as an inverter	08/27/2014

The revision history provided is for informational purposes only and is believed to be accurate.



CUI INC[®]

Headquarters
20050 SW 112th Ave.
Tualatin, OR 97062
800.275.4899

Fax 503.612.2383
cui.com
techsupport@cui.com

CUI offers a two (2) year limited warranty. Complete warranty information is listed on our website.

CUI reserves the right to make changes to the product at any time without notice. Information provided by CUI is believed to be accurate and reliable. However, no responsibility is assumed by CUI for its use, nor for any infringements of patents or other rights of third parties which may result from its use.

CUI products are not authorized or warranted for use as critical components in equipment that requires an extremely high level of reliability. A critical component is any component of a life support device or system whose failure to perform can be reasonably expected to cause the failure of the life support device or system, or to affect its safety or effectiveness.