

KAW SERIES

30W WIDE INPUT RANGE

DANUBE

FEATURES

- 30W DIL PACKAGE
- INDUSTRY STANDARD PACKAGE
- 9-18V, 18-36V, 36-72V, 9-36V, 18-72V WIDE INPUT RANGE
- 100% BURN IN
- HIGH EFFICIENCY
- UL 94V-0 PACKAGE MATERIAL
- CUSTOM SOLUTIONS AVAILABLE
- RoHS COMPLIANT
- 3 YEARS WARRANTY



OUTPUT SPECIFICATIONS

Voltage Setpoint Accuracy		
Single Output		+/-2% max
Dual Output		+/-2% max
Triple	5V	+/-2% max
	12V/15V	+/-5% max
Over Voltage Protection		Built-in
Temperature Coefficient		+/-0.05%/°C
Ripple & Noise(20MHz BW) ²		100mVp-p max
Line Regulation ³		
Single		+/-0.5% max
Dual		+/-0.5% max
Triple	5V	+/-0.5% max
	12V/15V	+/-1.0% max
Load Regulation ⁵		
Single		+/-0.5% max
Dual		+/-0.5% max
Triple		+/-5% max
Minimum load		10% of Full Load
Short Circuit Protection		Continuous
Short Circuit Restart		Automatic
External Trim Adj. Range		+/-10%
Over Load Protection		180% Typ
Transient Response ⁶		500uS max

INPUT SPECIFICATIONS

Input Voltage Range	2:1 or 4:1 Input Range
Input Filter	Pi Network
Protection	Fuse Recommended

GENERAL SPECIFICATIONS

Efficiency	75% min
Isolation Voltage ¹	1500 VDC min
Isolation Resistance	10 ⁹ ohms min
Isolation Capacitance	2500pF max
Switching Frequency	100KHz min
MTBF ⁴	>400,000 Hours
Weight	110g Typ
Case Material	Six-Side Shielded Case
Case Size	50.8mm*50.8mm*21mm
Potting Material	Epoxy(UL94-V0)
Conducted Emissions	EN55022 Class A
Radiated Emissions	EN55022 Class A

ENVIRONMENTAL SPECIFICATIONS

Operating Temperature	-40°C to +71°C
Storage Temperature	-55°C to +100°C
Case Temperature	+95°C max
Humidity	95% max
Cooling	Free-Air Convection

ALL SPECIFICATIONS TYPICAL AT NOMINAL LINE, FULL LOAD, AND 25 °C UNLESS OTHERWISE NOTED.

¹ For 10 seconds.

² Measured with 1uF ceramic capacitor connect to the output pins.

³ High Line to Low Line.

⁴ MIL-HDBK-217F @25 °C, Ground Benign.

⁵ Load Regulation is for output load current change from 10% to 100%.

⁶ 25% Step Load Change.

DANUBE

<http://www.danube.com.tw>

1

2013/06/27

● **SELECTION GUIDE(1)**
2:1 25W-30W OUTPUT

MODEL NUMBER	INPUT VOLTAGE (VDC)	OUTPUT VOLTAGE (VDC)	OUTPUT CURRENT (mA)	INPUT ⁷ CURRENT(mA)		EFF (%) ⁸	CAPACITOR LOAD (Max)
				FULL LOAD	NO LOAD		
KAWS-1203.3	9-18	3.3	6000	2063	40	80	2700uF
KAWS-1205	9-18	5	5000	2604	40	80	2700uF
KAWS-1209	9-18	9	3333	2950	40	84	2200uF
KAWS-1212	9-18	12	2500	2950	40	84	1800uF
KAWS-1215	9-18	15	2000	2950	38	84	1500uF
KAWS-1224	9-18	24	1250	2941	36	85	1000uF
KAWD-1205	9-18	+/-5	+/-2500	2604	40	80	+/-1200uF
KAWD-1212	9-18	+/-12	+/-1250	3125	40	80	+/-820uF
KAWD-1215	9-18	+/-15	+/-1000	3125	38	80	+/-680uF
KAWT-12/0512	9-18	+5,+/-12	3500,+/-310	2598	55	80	2700uF,+/-820uF
KAWT-12/0515	9-18	+5,+/-15	3500,+/-250	2604	40	80	2700uF,+/-680uF
KAWS-2403.3	18-36	3.3	6000	1012	20	82	2700uF
KAWS-2405	18-36	5	5000	1302	20	80	2700uF
KAWS-2405.1	18-36	5.1	5000	1302	20	80	2700uF
KAWS-2409	18-36	9	3333	1470	20	85	2200uF
KAWS-2410	18-36	10	3000	1470	19	85	2200uF
KAWS-2412	18-36	12	2500	1470	30	85	1800uF
KAWS-2415	18-36	15	2000	1470	30	85	1500uF
KAWS-2424	18-36	24	1250	1453	16	86	1000uF
KAWS-2442	18-36	42	710	1497	16	83	560uF
KAWD-2405	18-36	+/-5	+/-2500	1302	20	80	+/-1200uF
KAWD-2412	18-36	+/-12	+/-1250	1470	18	85	+/-820uF
KAWD-2415	18-36	+/-15	+/-1000	1470	30	85	+/-680uF
KAWD-2424	18-36	+/-24	+/-625	1470	18	85	+/-560uF
KAWT-24/0512	18-36	+5,+/-12	3500,+/-310	1267	18	82	2700uF,+/-820uF
KAWT-24/0515	18-36	+5,+/-15	3500,+/-250	1270	18	82	2700uF,+/-680uF
KAWS-4803.3	36-72	3.3	6000	522	10	80	2700uF
KAWS-4805	36-72	5	5000	651	10	80	2700uF
KAWS-4809	36-72	9	3333	762	10	82	2200uF
KAWS-4812	36-72	12	2500	762	9	82	1800uF
KAWS-4815	36-72	15	2000	762	9	82	1500uF
KAWS-4824	36-72	24	1250	753	8	83	1000uF
KAWD-4805	36-72	+/-5	+/-2500	651	10	80	+/-1200uF
KAWD-4812	36-72	+/-12	+/-1250	762	9	82	+/-820uF
KAWD-4815	36-72	+/-15	+/-1000	762	9	82	+/-680uF
KAWT-48/0512	36-72	+5,+/-12	3500,+/-310	634	9	82	2700uF,+/-820uF
KAWT-48/0515	36-72	+5,+/-15	3500,+/-250	635	9	82	2700uF,+/-680uF

Note: Other input to output voltages may be available. Please contact factory.

⁷ NOMINAL INPUT VOLTAGE.

⁸ NOMINAL INPUT VOLTAGE, FULL LOAD.

● **SELECTION GUIDE(2)**
4:1 25W-30W OUTPUT

MODEL NUMBER	INPUT VOLTAGE (VDC)	OUTPUT VOLTAGE (VDC)	OUTPUT CURRENT (mA)	INPUT ⁹ CURRENT(mA)		EFF (%) ¹⁰	CAPACITOR LOAD (Max)
				FULL LOAD	NO LOAD		
KAWS-1209T	9-36	9	3333	3182	40	79	2200uF
KAWS-1212T	9-36	12	2500	3100	40	81	1800uF
KAWS-1215T	9-36	15	2000	3100	38	81	1500uF
KAWS-1224T	9-36	24	1250	3100	36	81	1000uF
KAWD-1205T	9-36	+/-5	+/-2500	2604	40	80	+/-1200uF
KAWD-1212T	9-36	+/-12	+/-1250	3125	40	80	+/-820uF
KAWD-1215T	9-36	+/-15	+/-1000	3125	38	80	+/-680uF
KAWT-12/0512T	9-36	+5,+/-12	3500,+/-310	2598	40	80	2700uF,+/-820uF
KAWT-12/0515T	9-36	+5,+/-15	3500,+/-250	2604	40	80	2700uF,+/-680uF
KAWS-2405T	18-72	5	5000	1302	20	80	2700uF
KAWS-2412T	18-72	12	2500	1550	18	81	1800uF
KAWS-2415T	18-72	15	2000	1550	18	81	1500uF
KAWS-2424T	18-72	24	1250	1550	16	81	1000uF
KAWS-2430T	18-72	30	1000	1550	18	81	820uF
KAWD-2405T	18-72	+/-5	+/-2500	1302	20	80	+/-1200uF
KAWD-2412T	18-72	+/-12	+/-1250	1550	18	81	+/-820uF
KAWD-2415T	18-72	+/-15	+/-1000	1550	18	81	+/-680uF
KAWT-24/0512T	18-72	+5,+/-12	3500,+/-310	1267	18	82	2700uF,+/-820uF
KAWT-24/0515T	18-72	+5,+/-15	3500,+/-250	1270	18	82	2700uF,+/-680uF

Note: Other input to output voltages may be available. Please contact factory.

⁹ NOMINAL INPUT VOLTAGE.

¹⁰ NOMINAL INPUT VOLTAGE, FULL LOAD.

● SIMPLIFIED SCHEMATIC

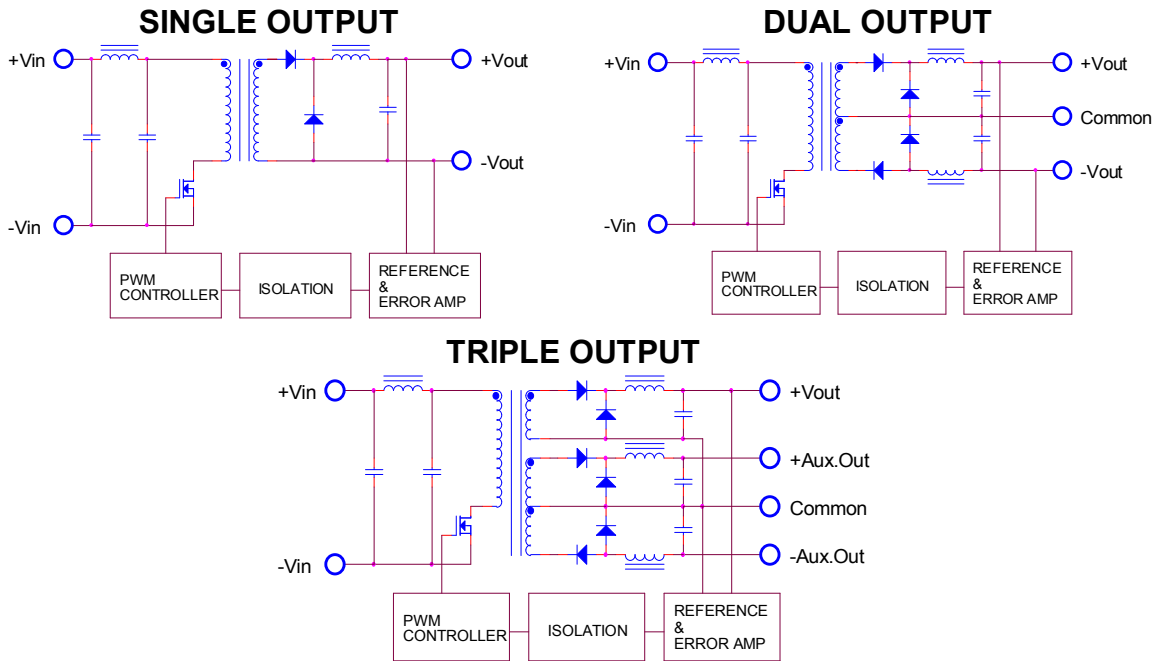

● MECHANICAL DIMENSIONS

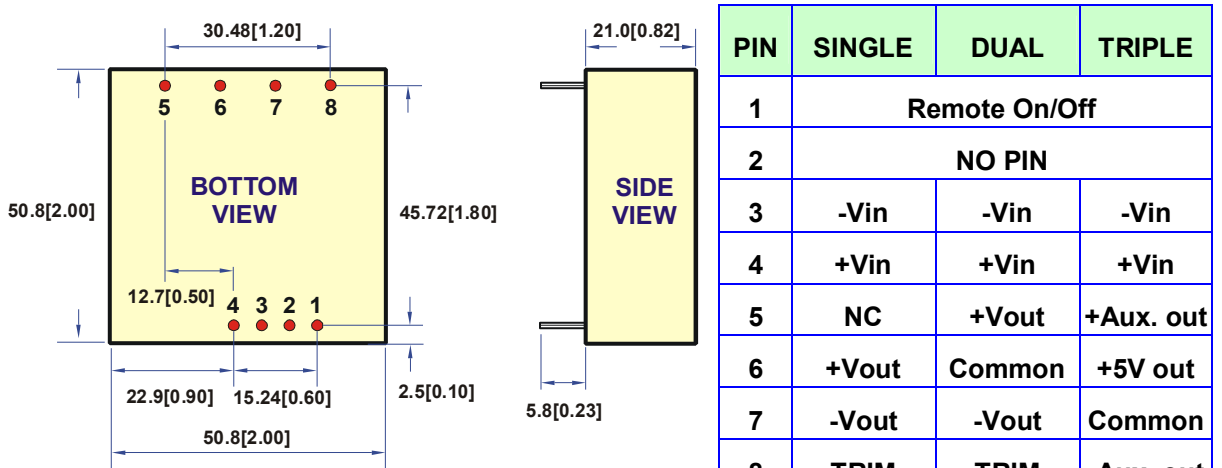

All dimensions are in millimeters[inches]

Note: **SINGLE OUTPUT for 24V : PIN 5 = NO PIN

Remote On/Off Control			
Control Input	PIN1	Control Common	PIN3
Control Voltage		Converter Shutdown Idle Current	10mA
ON	>+2.5VDC or Open Circuit	Logic Compatibility	CMOS or Open
OFF	<+0.8VDC or Jumper to PIN3		Collector TTL

● RECOMMENDED FOOTPRINT DETAILS

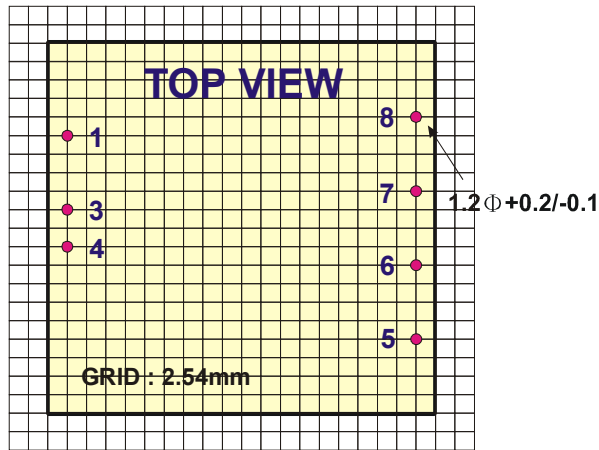

● TYPICAL APPLICATIONS

SINGLE OUTPUT

DUAL OUTPUT

FIXED VOLTAGE OUTPUT

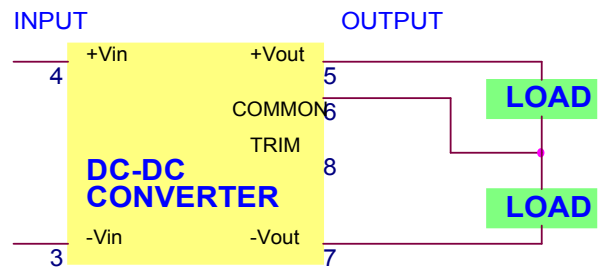
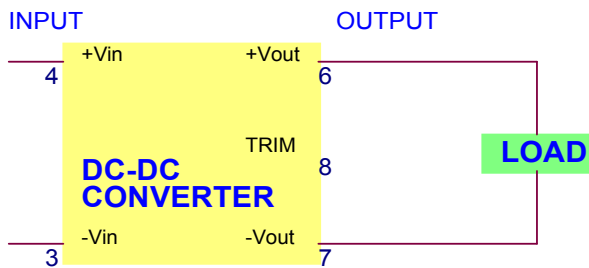

TRIM CONNECTIONS USING A TRIMPOT

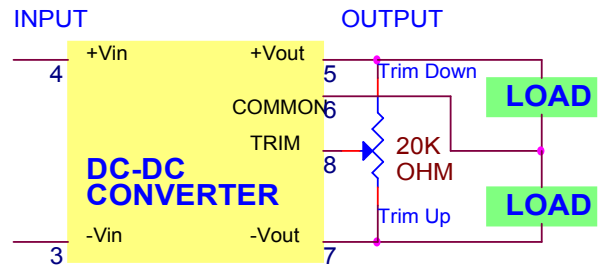
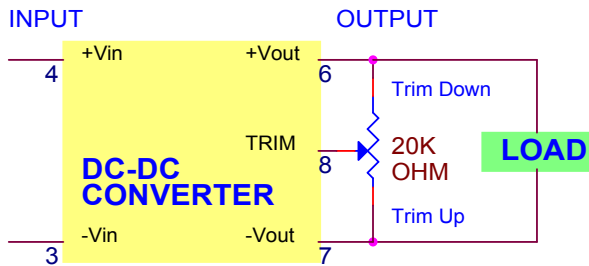

FIXED-VALUE TRIM DOWN RESISTOR

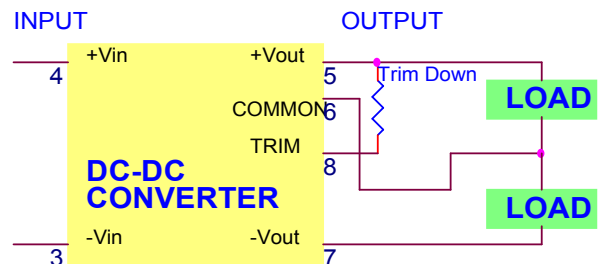
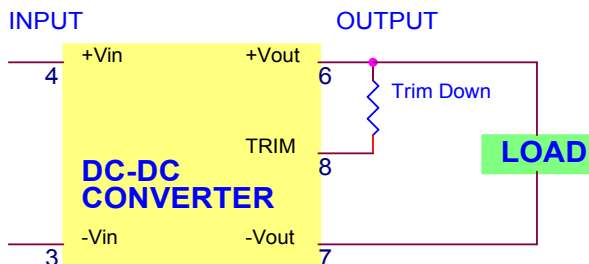

FIXED-VALUE TRIM UP RESISTOR

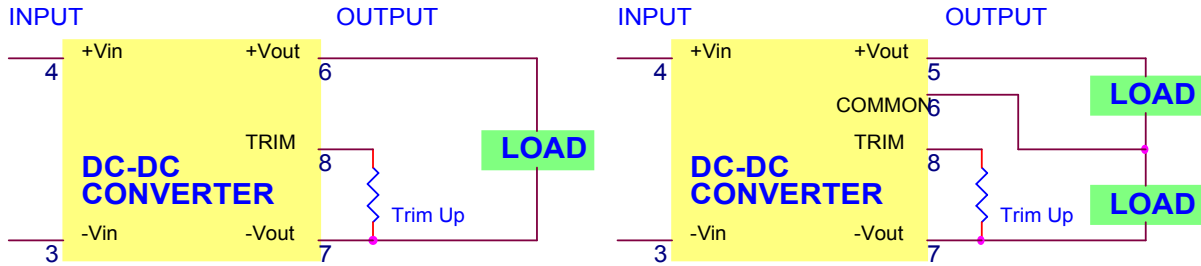

TRIPLE OUTPUT

FIXED VOLTAGE OUTPUT

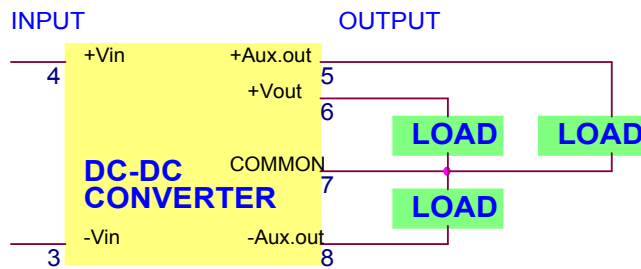

● TYPICAL PERFORMANCE CURVES

Specifications typical at $T_a=25^\circ\text{C}$, nominal input voltage, rated output current unless otherwise specified.

OUTPUT LOAD VS EFFICIENCY

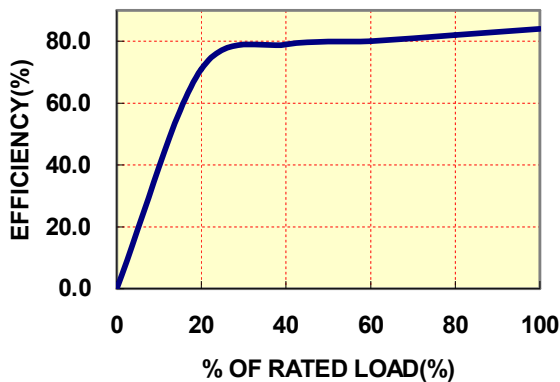

TEMPERATURE DERATING

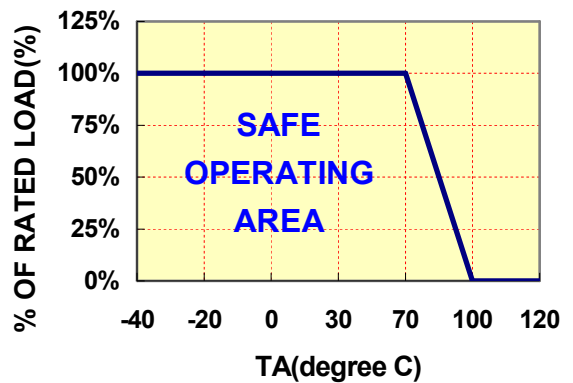

● Recommended Filter for EN55022 Class B Compliance

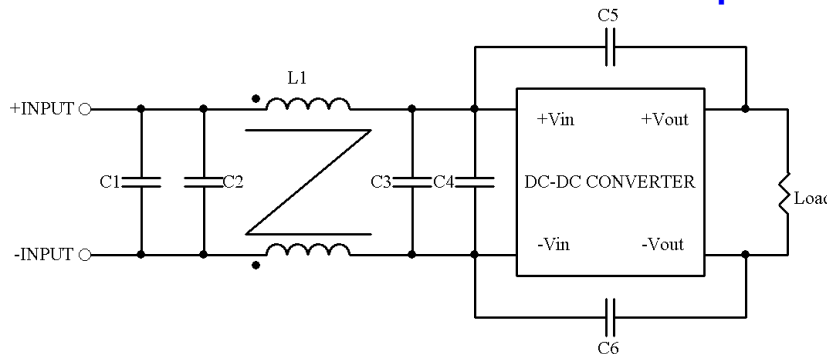

The components used in the above figure, together with the manufacturer's part numbers for these components, are as follows :

	C1	C2	C3	C4	C5	C6	L1
KAWS-12XXX	4.7uF/50V 1812 MLCC	N/A	4.7uF/50V 1812 MLCC	N/A	1000pF/2KV MLCC	1000pF/2KV MLCC	450uH Common Choke
KAWS-24XXX	6.8uF/50V 1812 MLCC	N/A	6.8uF/50V 1812 MLCC	N/A	1000pF/2KV MLCC	1000pF/2KV MLCC	450uH Common Choke
KAWS-48XXX	2.2uF/100V 1812 MLCC	2.2uF/100V 1812 MLCC	2.2uF/100V 1812 MLCC	2.2uF/100V 1812 MLCC	1000pF/2KV MLCC	1000pF/2KV MLCC	450uH Common Choke

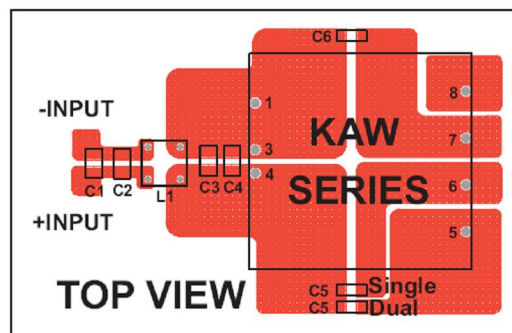

Recommended EN55022 Class B Filter Circuit Layout

● INPUT FUSE SELECTION GUIDE

9-18V or 9-36V INPUT VOLTAGE(VDC)	18-36V or 18-72V INPUT VOLTAGE(VDC)	36-72V INPUT VOLTAGE(VDC)
6000mA Slow-Blow Type	3000mA Slow-Blow Type	1500mA Slow-Blow Type

Note: Certain applications may require the installation of external fuse in front of the input.

KAW SERIES APPLICATION NOTES:

EXTERNAL CAPACITANCE REQUIREMENTS:

No external capacitance is required for operation of the KAW series.

To meet the reflected ripple requirements of the converter, an input impedance of less than 0.5 ohm from DC to 220KHz is required.

External output capacitance is not required for operation, however it is recommended that 10uF tantalum and 0.1uF ceramic capacitance be selected for reduced system noise.

Additional output capacitance may be added for increased filtering, but should not exceed 2200uF.

We Can Offer EMC-Filter According To EN55011/22 Class B.

Negative Outputs:

A negative output voltage may be obtained by connecting the +OUT to circuit ground and connecting -OUT as the negative output.

Remote ON/OFF:

The remote ON/OFF pin may be left floating if this function is not use. It is recommended to drive this pin with an open collector arrangement or a relay contact. When the ON/OFF pin is pulled low with respect to the -Vin , the converter is placed in a low power drain state.

Output TRIM:

The TRIM pin may be used to adjust the output +/-10% from the nominal setting .this function allows adjustment for voltage drops in the system wiring. If the TRIM function is not required the pin may be left floating.

FOR MORE INFORMATION CALL:

Danube Enterprise Co., Ltd.

Tel: 886-7-3755165

Fax: 886-7-3755330

E-mail: danube@ms10.hinet.net

Home Page

<http://www.danube.com.tw>
