

KDW SERIES

30W-40W WIDE INPUT RANGE

DANUBE

FEATURES

- 30-40W DIL PACKAGE
- SIX-SIDE SHIELDED CASE
- INDUSTRY STANDARD PACKAGE
- 9-18V,18-36V,36-72V WIDE INPUT RANGE
- 100% BURN IN
- HIGH EFFICIENCY
- RoHS COMPLIANT
- 3 YEARS PRODUCT WARRANTY



OUTPUT SPECIFICATIONS

Voltage Set-point Accuracy	+/-2% max.
Temperature Coefficient	+/-0.05%/°C
Ripple & Noise(20MHz BW) ¹	100mVp-p max.
Line Regulation ²	+/-0.5% max.
Load Regulation ³	+/-0.5% max.
Minimum load	10% of Full Load
Short Circuit Protection	Continuous
Over Voltage Protection	Built-in
External Trim Adj. Range	+/-10%

ENVIRONMENTAL SPECIFICATIONS

Operating Temperature	-40 °C to +71 °C
Storage Temperature	-55 °C to +100 °C
Cooling	Free-Air Convection

INPUT SPECIFICATIONS

Input Voltage Range	2:1 INPUT RANGE
Input Filter	Pi Network

GENERAL SPECIFICATIONS

Efficiency	80% min.
Isolation Voltage ⁴	1500 VDC min.
Isolation Resistance	10 ⁹ ohms min.
Isolation Capacitance	1200pF max.
Switching Frequency	100 KHz min.
MTBF ⁵	>700,000 Hours
Weight	110g Typ.
Case Material	Six-Side Shielded Case
Case Size	50.8mm*50.8mm*21mm
Potting Material	Epoxy(UL94-V0)
Conducted Emissions	EN55022 Class A
Radiated Emissions	EN55022 Class A

ALL SPECIFICATIONS TYPICAL AT NOMINAL LINE, FULL LOAD, AND 25 °C UNLESS OTHERWISE NOTED.

¹ Measured with 1uF ceramic capacitor connect to the output pins.

² High Line to Low Line.

³ Load Regulation is for output load current change from 10% to 100%.

⁴ For 10 seconds.

⁵ MIL-HDBK-217F @25 °C, Ground Benign.

DANUBE

<http://www.danube.com.tw>

1

2013/06/26

● **SELECTION GUIDE**
2:1 30W~40W OUTPUT

MODEL NUMBER	INPUT VOLTAGE (VDC)	OUTPUT VOLTAGE (VDC)	OUTPUT CURRENT (mA)	INPUT ⁶ CURRENT(mA)		EFF (%) ⁷	CAPACITOR LOAD (Max)
				FULL LOAD	NO LOAD		
				KDWS-1212	9-18		
KDWS-1215	9-18	15	2400	3655	40	82	3300uF
KDWS-1224	9-18	24	1500	3640	40	82	2200uF
KDWS-1230	9-18	30	1200	3645	40	82	1000uF
KDWS-2412	18-36	12	3000	1820	18	82	4700uF
KDWS-2415	18-36	15	2400	1810	18	83	3300uF
KDWS-2424	18-36	24	1667	1950	18	85	2200uF
KDWD-2412	18-36	+/-12	+/-1650	1960	18	85	+/-2200uF
KDWD-2415	18-36	+/-15	+/-1300	1960	18	85	+/-1000uF
KDWS-4812	36-72	12	3000	910	9	82	4700uF
KDWS-4815	36-72	15	2400	902	9	83	3300uF
KDWS-4824	36-72	24	1667	976	9	85	2200uF
KDWD-4812	36-72	+/-12	+/-1650	980	9	85	+/-2200uF
KDWD-4815	36-72	+/-15	+/-1300	980	9	85	+/-1000uF

Note: Other input to output voltages may be available. Please contact factory.

⁶ NOMINAL INPUT VOLTAGE.

⁷ NOMINAL INPUT VOLTAGE, FULL LOAD.

● SIMPLIFIED SCHEMATIC

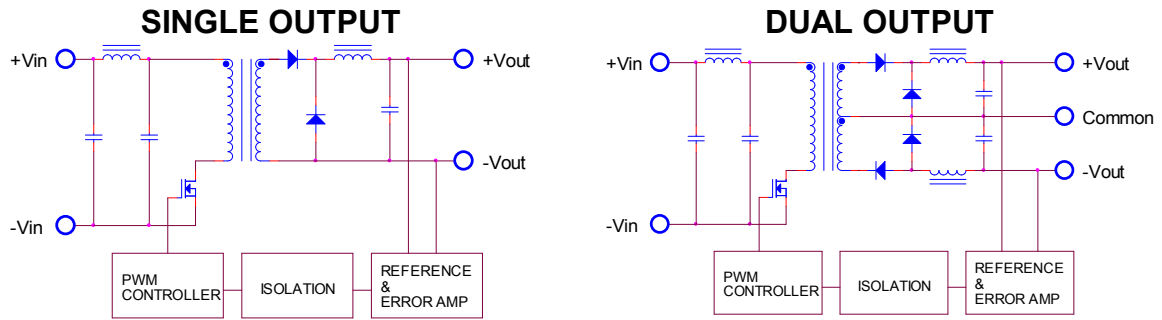

● MECHANICAL DIMENSIONS

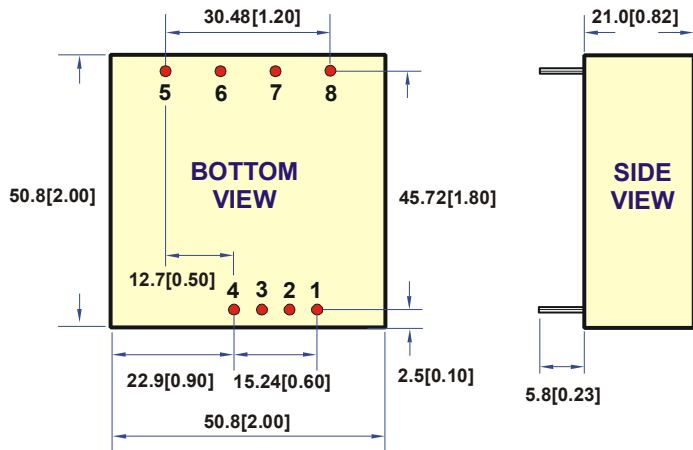

PIN	SINGLE	DUAL
1	Remote On/Off	
2	NO PIN	
3	-Vin	-Vin
4	+Vin	+Vin
5	NC	+Vout
6	+Vout	Common
7	-Vout	-Vout
8	TRIM	TRIM

All dimensions are in millimeters[inches]

Note: **SINGLE OUTPUT for 24V: PIN 5 = NO PIN

Remote On/Off Control			
Control Input	PIN1	Control Common	PIN3
Control Voltage		Converter Shutdown Idle Current	10mA
ON	>+2.5VDC or Open Circuit	Logic Compatibility	CMOS or Open
OFF	<+0.8VDC or Jumper to PIN3		Collector TTL

● RECOMMENDED FOOTPRINT DETAILS

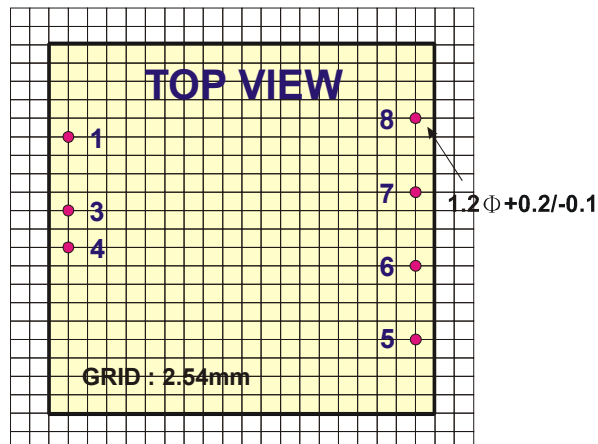

TYPICAL APPLICATIONS

SINGLE OUTPUT

DUAL OUTPUT

FIXED VOLTAGE OUTPUT

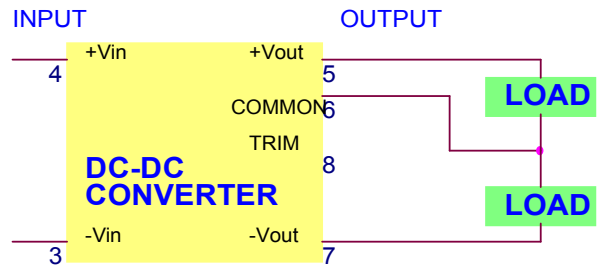
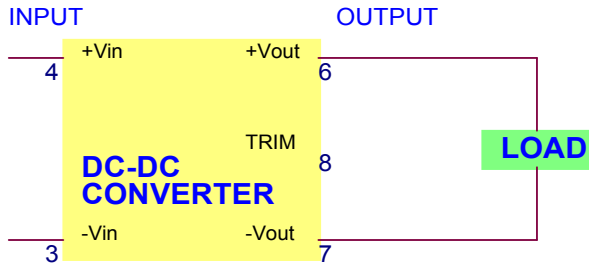

TRIM CONNECTIONS USING A TRIMPOT

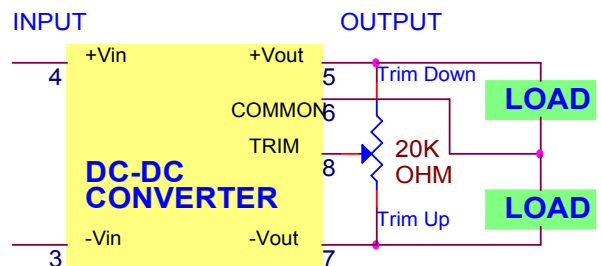
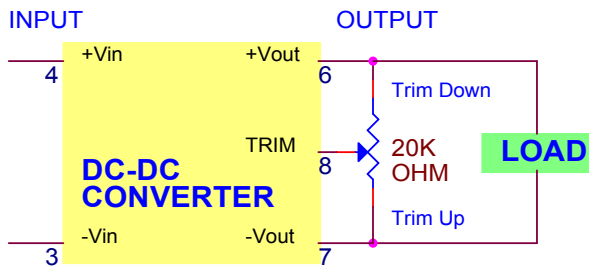

FIXED-VALUE TRIM DOWN RESISTOR

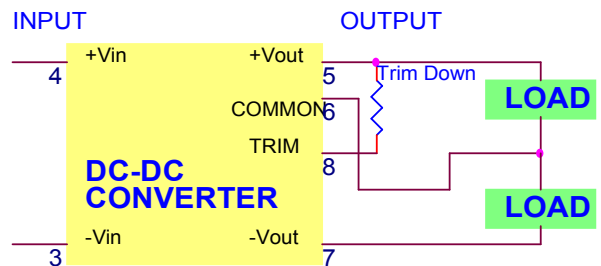
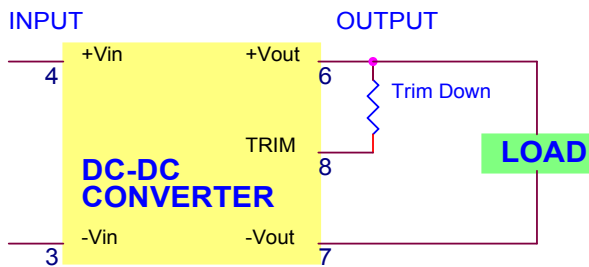

FIXED-VALUE TRIM UP RESISTOR

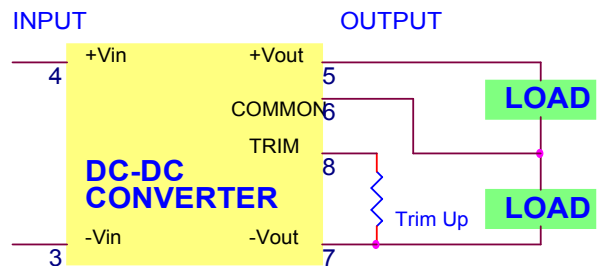
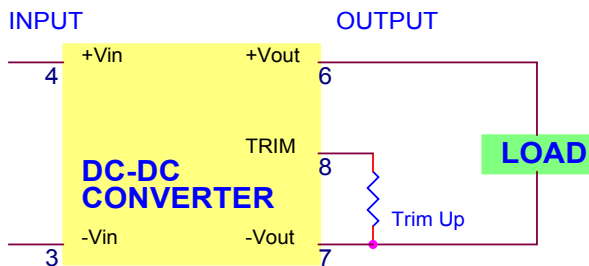

● TYPICAL PERFORMANCE CURVES

Specifications typical at $T_a=25^\circ\text{C}$, nominal input voltage, rated output current unless otherwise specified.

OUTPUT LOAD VS EFFICIENCY

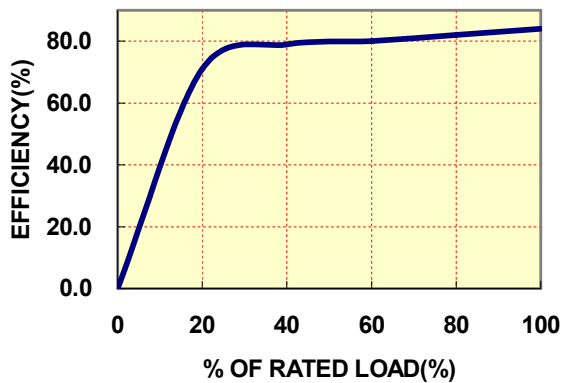

TEMPERATURE DERATING

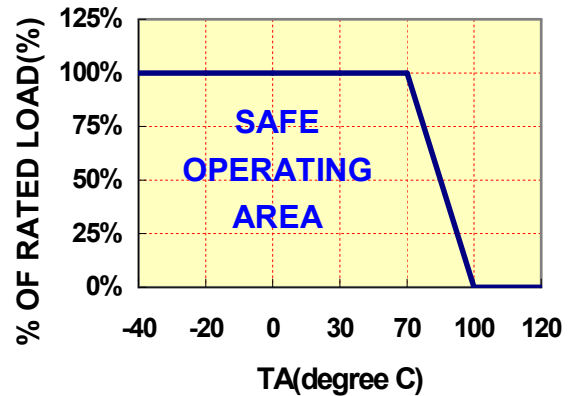

● INPUT FUSE SELECTION GUIDE

9-18V INPUT VOLTAGE(VDC)	18-36V INPUT VOLTAGE(VDC)	36-72V INPUT VOLTAGE(VDC)
10000mA Slow-Blow Type	6000mA Slow-Blow Type	3000mA Slow-Blow Type

Note: Certain applications may require the installation of external fuse in front of the input.

KDW SERIES APPLICATION NOTES:

EXTERNAL CAPACITANCE REQUIREMENTS:

No external capacitance is required for operation of the KDW series.

To meet the reflected ripple requirements of the converter, an input impedance of less than 0.5 ohm from DC to 220 KHz is required.

External output capacitance is not required for operation; however it is recommended that 10uF tantalum and 0.1uF ceramic capacitance be selected for reduced system noise.

Additional output capacitance may be added for increased filtering, but should not exceed 2200uF.

We Can Offer EMC-Filter According To EN55011/22 Class B

Negative Outputs:

A negative output voltage may be obtained by connecting the +OUT to circuit ground and connecting -OUT as the negative output.

Remote ON/OFF:

The remote ON/OFF pin may be left floating if this function is not use. It is recommended to drive this pin with an open collector arrangement or a relay contact. When the ON/OFF pin is pulled low with respect to the –VIN, the converter is placed in a low power drain state.

Output TRIM:

The TRIM pin may be used to adjust the output +/-10% from the nominal setting .this function allows adjustment for voltage drops in the system wiring. If the TRIM function is not required the pin may be left floating.

FOR MORE INFORMATION CALL:

Danube Enterprise Co., Ltd.

Tel: 886-7-3755165

Fax: 886-7-3755330

E-mail: danube@ms10.hinet.net

Home Page

<http://www.danube.com.tw>
