

Features

- 4:1 Wide Input Voltage Range
- 30 Watts Output Power
- 1.6kVDC Isolation
- UL Certified
- Fixed Operating Frequency
- Six-Sided Continuous Shield
- Standard 50.8 x 25.4 x 10.2mm Package
- Efficiency to 91%

Description

The RP30-FW series DC/DC converters are designed to meet to UL 60950-1 and to cUL 60950-1. This makes them ideal for all telecom and industrial applications where approved safety standards are required. The industry standard 2" x 1" package meets military standards for thermal shock and vibration tolerance.

Selection Guide 24V and 48V Input Types

Part Number	Input Range	Output Voltage	Output Current	Input Current ⁽⁴⁾		Efficiency ⁽⁵⁾	Capacitive ⁽⁶⁾ Load max.
	VDC	VDC	mA	No Load	Full Load		
RP30-243.3SFW	9-36	3.3	7500	70	1258	86	20000µF
RP30-2405SFW	9-36	5	6000	105	1488	88	14400µF
RP30-2412SFW	9-36	12	2500	20	1471	89	3000µF
RP30-2415SFW	9-36	15	2000	30	1471	89	2000µF
RP30-483.3SFW	18-75	3.3	7500	45	629	86	20000µF
RP30-4805SFW	18-75	5	6000	65	744	88	14400µF
RP30-4812SFW	18-75	12	2500	60	727	90	3000µF
RP30-4815SFW	18-75	15	2000	50	718	91	2000µF
RP30-2405DFW	9-36	±5	±3000	90	1488	88	±3000µF
RP30-2412DFW	9-36	±12	±1250	25	1506	87	±2000µF
RP30-2415DFW	9-36	±15	±1000	25	1506	87	±1300µF
RP30-4805DFW	18-75	±5	±3000	50	744	88	±3000µF
RP30-4812DFW	18-75	±12	±1250	15	744	88	±2000µF
RP30-4815DFW	18-75	±15	±1000	15	744	88	±1300µF

* no suffix for CTRL function with Positive Logic (1=ON, 0=OFF), this is standard

* add **N** for CTRL function with Negative Logic (0=ON, 1=OFF)

* add suffix **-HC** for premounted heatsink and clips

Ordering Examples

RP30-2405SFW = 24V Input, 5V Output, Positive Logic CTRL pin fitted

RP30-4812DFW/N-HC = 48V Input, ±12V Output, Negative Logic CTRL pin fitted, Heatsink fitted

Derating graphs are valid only for the shown part numbers. If you need detailed derating-information about a part-number not shown here please contact our technical support service at info@recom-development.at

POWERLINE

DC/DC-Converter

with 3 year Warranty

RECOM

30 Watt 2" x 1" Single & Dual Output

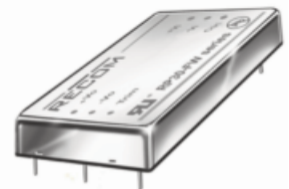

UL-60950-1 Certified

RP30-FW

Derating-Graph

(Ambient Temperature)

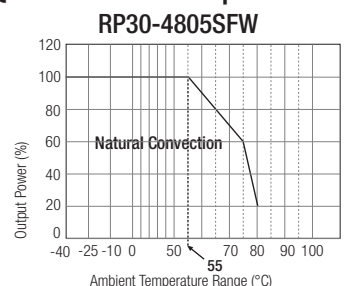

RP30-4805SFW With Heat Sink

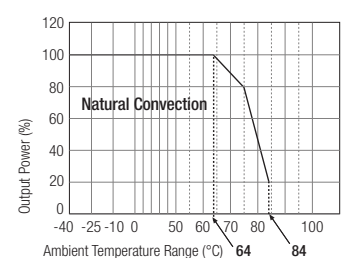

Refer to Application Notes

Typical Characteristics

RP30-4805SFW

Efficiency VS Input Voltage

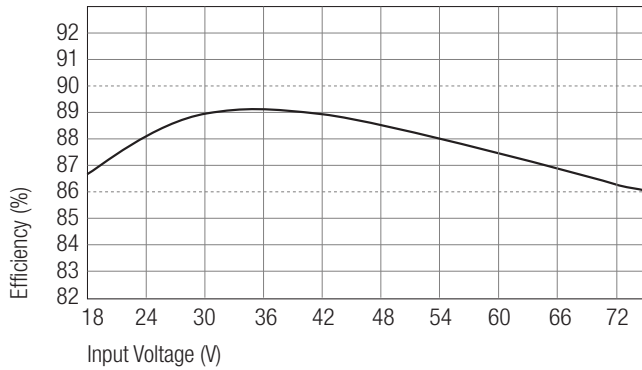

RP30-4805SFW

Efficiency VS Output Load

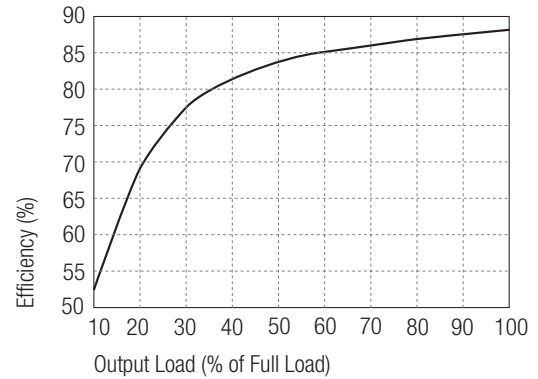

Specifications (typical at nominal input and 25°C unless otherwise noted)

Input Voltage Range	24V nominal input	9-36VDC
	48V nominal input	18-75VDC
Input Filter		Pi Type
Input Surge Voltage (100 ms max.)	24V Input	50VDC
	48V Input	100VDC
Input Reflected Ripple (nominal Vin and full load) ⁽³⁾		20mAp-p
Start Up Time (nominal Vin and constant resistor load)	Power up	30ms typ.
	Remote ON/OFF	30ms typ.
Start-up voltage	24V Input	9VDC
	48V Input	18VDC
Shutdown voltage	24V Input	8VDC
	48V Input	16VDC
Remote ON/OFF ⁽⁷⁾		
(Positive logic)(Standard)	DC-DC ON	Open or 3V < Vr < 12V
	DC-DC OFF	Short or 0V < Vr < 1.2V
(Negative logic)(Option)	DC-DC ON	Short or 0V < Vr < 1.2V
	DC-DC OFF	Open or 3V < Vr < 12V
Input current of Remote control pin	Nominal input	-0.5mA ~ +0.5mA
Remote OFF state input current	Nominal input	3mA
Output Power		30W max.
Output Voltage Accuracy (full Load and nominal Vin)		±1%
Voltage Adjustability		±10%
Minimum Load		0%
Line Regulation (low line, high line at full load)		±0.2%

continued on next page

Specifications (typical at nominal input and 25°C unless otherwise noted)

Load Regulation (No load to full load)	Single	±0.5%
	Dual	±1%
Cross Regulation (asymmetrical 25% <>100% load)	Dual	±5%
Temperature Coefficient		±0.02%/°C max.
Transient Response (25% load step change)		250µs
Over Voltage Protection	3.3V	3.9V
Zener diode clamp (only single)	5V, ±5V	6.2V
	12V, ±12V	15V
	15V, ±15V	18V
Over Load Protection (% of full load at nominal Vin)		150% typ
Short Circuit Protection		Hiccup, automatic recovery
Efficiency		see „Selection Guide“ table
Isolation Voltage (rated for one minute)	Input to Output	1600VDC
	Input (Output) to case	1600VDC
Isolation Resistance		1GΩ min.
Isolation Capacitance		1500pF max.
Operating Frequency		430kHz typ.
Operating Temperature Range		-40°C to +50°C(without derating)
		-40°C to +85°C(with derating)
Maximum Case Temperature		+105°C
Storage Temperature Range		-55°C to +125°C
Over Temperature Protection		+115°C typ.
Thermal Impedance ⁽⁸⁾	Natural convection	12°C/Wat
	Natural convection with Heat Sink	10°C/Watt
Thermal Shock		MIL-STD-810F
Vibration		MIL-STD-810F
Relative Humidity		5% to 95% RH
Case Material		Nickel plated copper
Base Material		FR4 PCB
Potting Material		Epoxy (UL94-V0)
Conducted Emissions ⁽¹⁰⁾	EN55022	Class A
Radiated Emissions	EN55022	Class B
ESD	EN61000-4-2	Air ±8KV Perf. Criteria A
	EN61000-4-2	Contact ±6KV Perf. Criteria A
Radiated Immunity	EN61000-4-3	10V/m Perf. Criteria A
Fast Transient ⁽⁹⁾	EN61000-4-4	±2KV Perf. Criteria A
Surge ⁽⁹⁾	EN61000-4-5	±1KV Perf. Criteria A
Conducted Immunity	EN61000-4-6	10 Vr.m.s Perf. Criteria A
Weight		30.5g
Packing Quantity	Refer to App Notes for tube dimensions	9 pcs per Tube
Dimensions		50.8 x 25.4 x 10.2mm
MTBF ⁽²⁾	Belcore-TR-NWT-000332	3.163 x 10 ⁶ hours
	MIL-HDBK-217F	4.347 x 10 ⁵ hours

Notes :

1. The RP30-S_DFW series does not require any minimum load.
2. BELLCORE TR-NWT-000332. Case I: 50% Stress, Temperature at 40°C (Ground fixed and controlled environment)
MIL-HDBK-217F Notice2 @ TA= 25°C, Full load (Ground, Benign, controlled environment)
3. Simulated source impedance of 12μH. 12μH inductor in series with +Vin.
4. Typical value at nominal input voltage and no load of standard type
Maximum value at nominal input voltage and full load of standard type.
5. Typical value at nominal input voltage and full load.
6. Test by minimum Vin and constant resistor load.
7. The ON/OFF control function can be positive or negative logic. The pin voltage is referenced to negative input.
Positive logic ON/OFF is standard, no suffix (Ex. RP30-2405SFW)
Negative logic ON/OFF is marked with suffix-N (Ex. R320-2405SFW/N).
8. Heat sink is optional and P/N: 7G-0020-C . Powerline DC/DC Converters can be ordered with pre-mounted heatsinks including antivibration fixing clips (add suffix -HC). See Application Notes for heatsink details.
9. An external filter capacitor is required if the module has to meet EN61000-4-4,EN61000-4-5.
The filter capacitor RECOM suggest: 24Vin : Nippon chemi-con KY series, 330μF/50V, ESR 55mΩ.
48Vin : Nippon chemi-con KY series, 220μF/100V, ESR 48mΩ.
10. Meets class A with external components shown below. See application notes for Class B common mode filter suggestion

Package Style and Pinning (mm)

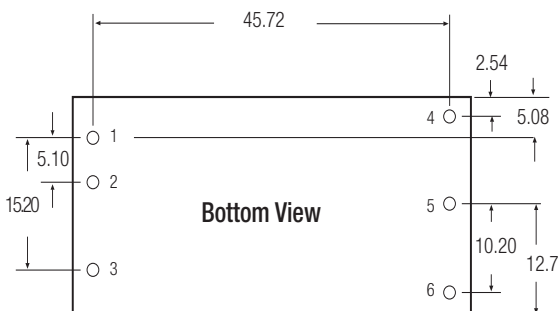
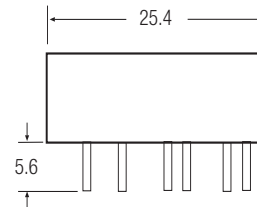
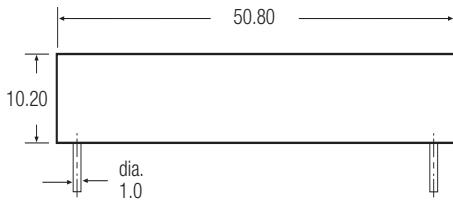

Pin Connections

Pin #	Single	Dual
1	+Vin	+Vin
2	-Vin	-Vin
3	CTRL	CTRL
4	+Vout	+Vout
5	-Vout	Com
6	Trim	-Vout

Pin Pitch Tolerance ±0.25 mm

EMC Filtering - For Class A filter suggestion, see Application Notes

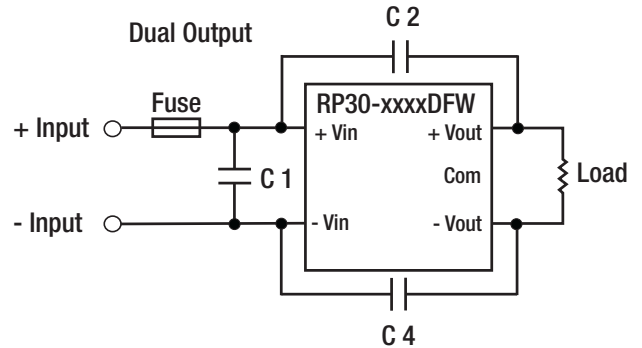
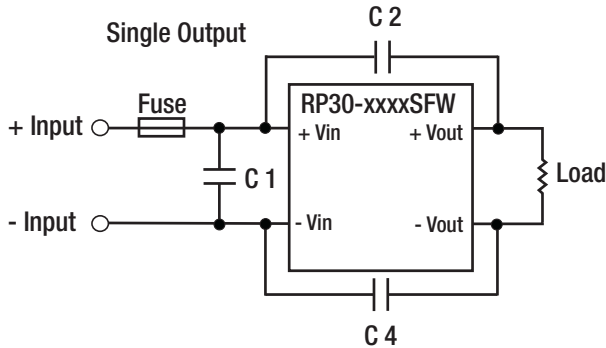

Single Output	C1	C2 & C3
RP30-24xxSFW	6.8 μ F/50V 1812 MLCC	1000pF/2KV 1808 MLCC
RP30-48xxSFW	2.2 μ F/100V 1812 MLCC	1000pF/2KV 1808 MLCC

Dual Output	C1	C2 & C4
RP30-24xxDFW	6.8 μ F/50V 1812 MLCC	1000pF/2KV 1808 MLCC
RP30-48xxDFW	2.2 μ F/100V 1812 MLCC	1000pF/2KV 1808 MLCC

Recommended EN55022 Class A Filter Circuit Layouts

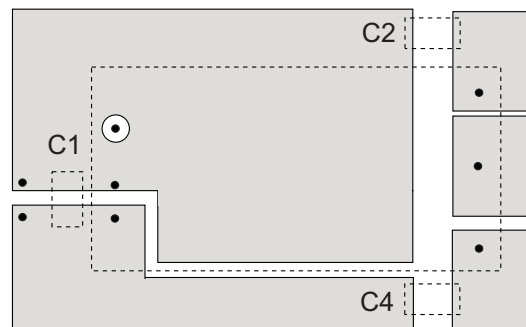
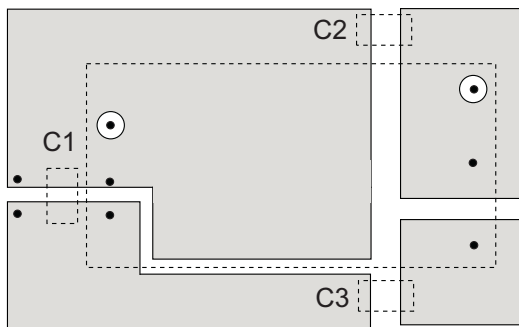

External Output Trimming

Output can be externally trimmed by using the method shown below. See Application Notes for details.

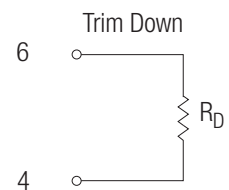
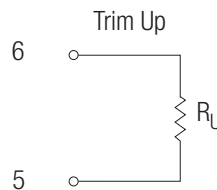

The product information and specifications are subject to change without prior notice. All products are designed for non-safety critical commercial and industrial applications. The Buyer agrees to implement safeguards that anticipate the consequences of any failures that might cause harm, loss of life and/or damage property.